

LM393B, LM2903B, LM193, LM293, LM393 and LM2903 Dual Comparators

1 Features

- NEW [LM393B](#) and [LM2903B](#)
- Improved specifications of B-version
 - Maximum rating: up to 38 V
 - ESD rating (HBM): 2k V
 - Low input offset: 0.37 mV
 - Low input bias current: 3.5 nA
 - Low supply-current: 200 μ A per comparator
 - Faster response time of 1 μ sec
 - Extended temperature range for LM393B
 - Available in tiny 2 x 2mm WSON package
- B-version is drop-in replacement for LM293, LM393 and LM2903, A and V versions
- Common-mode input voltage range includes ground
- Differential input voltage range equal to maximum-rated supply voltage: ± 38 V
- Low output saturation voltage
- Output compatible with TTL, MOS, and CMOS

2 Applications

- [Vacuum robot](#)
- [Single phase UPS](#)
- [Server PSU](#)
- [Cordless power tool](#)
- [Wireless infrastructure](#)
- [Appliances](#)
- [Building automation](#)
- [Factory automation & control](#)
- [Motor drives](#)
- [Infotainment & cluster](#)

3 Description

The [LM393B](#) and [LM2903B](#) devices are the next generation versions of the industry-standard LM393 and LM2903 comparator family. These next generation B-version comparators feature lower offset voltage, higher supply voltage capability, lower supply current, lower input bias current, lower propagation delay, and improved 2 kV ESD performance and input ruggedness through dedicated ESD clamps. The LM393B and LM2903B can drop-in replace the LM293, LM393 and LM2903, for both "A" and "V" grades.

All devices consist of two independent voltage comparators that are designed to operate from a single power supply over a wide range of voltages. Quiescent current is independent of the supply voltage.

Device Information

| PART NUMBER | PACKAGE ⁽¹⁾ | BODY SIZE (NOM) |
|---|------------------------|-------------------|
| LM393B, LM2903B, LM193, LM293, LM293A, LM393, LM393A, LM2903, LM2903V, LM2903AV | SOIC (8) | 4.90 mm x 3.91 mm |
| LM393B, LM2903B, LM293, LM293A, LM393, LM393A, LM2903 | VSSOP (8) | 3.00 mm x 3.00 mm |
| LM293, LM393, LM393A, LM2903 | PDIP (8) | 9.81 mm x 6.35 mm |
| LM393, LM393A, LM2903 | SO (8) | 6.20 mm x 5.30 mm |
| LM393B, LM2903B, LM393, LM393A, LM2903, LM2903V, LM2903AV | TSSOP (8) | 3.00 mm x 4.40 mm |
| LM393B, LM2903B | SOT-23 (8) | 2.90 mm x 1.60 mm |
| LM393B, LM2903B | WSON (8) | 2.00 mm x 2.00 mm |

(1) For all available packages, see the orderable addendum at the end of the data sheet.

Family Comparison Table

| Specification | LM393B | LM2903B | LM393 LM393A | LM2903 | LM2903V LM2903AV | LM193 | LM293 LM293A | Units |
|--------------------------------------|------------|------------|--------------------|------------|---------------------|------------|--------------------|--------------|
| Supply Voltage | 2 to 36 | 2 to 36 | 2 to 30 | 2 to 30 | 2 to 32 | 2 to 30 | 2 to 30 | V |
| Total Supply Current (5V to 36V max) | 0.6 to 0.8 | 0.6 to 0.8 | 1 to 2.5 | 1 to 2.5 | 1 to 2.5 | 1 to 2.5 | 1 to 2.5 | mA |
| Temperature Range | -40 to 85 | -40 to 125 | 0 to 70 | -40 to 125 | -40 to 125 | -55 to 125 | -25 to 85 | $^{\circ}$ C |
| ESD (HBM) | 2000 | 2000 | 1000 | 1000 | 1000 | 1000 | 1000 | V |
| Offset Voltage (Max over temp) | ± 4 | ± 4 | ± 9 ± 4 | ± 15 | ± 15 ± 4 | ± 9 | ± 9 ± 4 | mV |
| Input Bias Current (typ / max) | 3.5 / 25 | 3.5 / 25 | 25 / 250 | 25 / 250 | 25 / 250 | 25 / 100 | 25 / 250 | nA |
| Response Time (typ) | 1 | 1 | 1.3 | 1.3 | 1.3 | 1.3 | 1.3 | μ sec |



Table of Contents

| | | | |
|--|----|---|----|
| 1 Features | 1 | 6.13 Switching Characteristics: LM193, LM239, LM393, LM2903, all 'A' and 'V' versions..... | 11 |
| 2 Applications | 1 | 6.14 Typical Characteristics, LMx93, LM2903 (all 'V' and 'A' suffixes)..... | 12 |
| 3 Description | 1 | 6.15 Typical Characteristics, LM393B and LM2903B..... | 13 |
| 4 Revision History | 2 | 7 Detailed Description | 19 |
| 5 Pin Configuration and Functions | 4 | 7.1 Overview..... | 19 |
| 6 Specifications | 5 | 7.2 Functional Block Diagram..... | 19 |
| 6.1 Absolute Maximum Ratings..... | 5 | 7.3 Feature Description..... | 19 |
| 6.2 Recommended Operating Conditions..... | 5 | 7.4 Device Functional Modes..... | 19 |
| 6.3 Thermal Information: LM193..... | 6 | 8 Application and Implementation | 20 |
| 6.4 Thermal Information: LM293, LM393, LM2903 (all 'V' and 'A' suffixes)..... | 6 | 8.1 Application Information..... | 20 |
| 6.5 Thermal Information: LM393B and LM2903B..... | 6 | 8.2 Typical Application..... | 20 |
| 6.6 ESD Ratings..... | 6 | 9 Device and Documentation Support | 23 |
| 6.7 Electrical Characteristics LM393B | 7 | 9.1 Receiving Notification of Documentation Updates..... | 23 |
| 6.8 Electrical Characteristics LM2903B | 8 | 9.2 Support Resources..... | 23 |
| 6.9 Switching Characteristics LM393B and LM2903B..... | 8 | 9.3 Trademarks..... | 23 |
| 6.10 Electrical Characteristics for LM193, LM293, and LM393 (without A suffix)..... | 9 | 9.4 Electrostatic Discharge Caution..... | 23 |
| 6.11 Electrical Characteristics for LM293A and LM393A..... | 10 | 9.5 Glossary..... | 23 |
| 6.12 Electrical Characteristics for LM2903, LM2903V, and LM2903AV..... | 11 | 10 Mechanical, Packaging, and Orderable Information | 23 |

4 Revision History

NOTE: Page numbers for previous revisions may differ from page numbers in the current version.

| Changes from Revision AE (November 2020) to Revision AF (August 2023) | Page |
|--|-------------|
| • Added reference to Application Note..... | 20 |

| Changes from Revision AD (October 2020) to Revision AE (November 2020) | Page |
|---|-------------|
| • Corrected Family Comparison Table Offset Voltage units to mV..... | 1 |
| • LM393B and LM2903B recommended minimum supply voltage changed to 2V throughout..... | 1 |
| • Added separate offset voltage row for LM393B and LM2903B DGK package..... | 1 |
| • Changed "B" devices recommended minimum supply voltage to 2V..... | 5 |
| • Updated "B" device Supply Current vs Supply Voltage Graph for 2V..... | 13 |

| Changes from Revision AC (February 2020) to Revision AD (October 2020) | Page |
|--|-------------|
| • Updated the numbering format for tables, figures and cross-references throughout the document..... | 1 |

| Changes from Revision AB (December 2019) to Revision AC (February 2020) | Page |
|--|-------------|
| • Changed front page Features, Applications and Description text to highlight B version..... | 1 |
| • Added WSON and SOT-23-8 packages..... | 1 |
| • Added Links to Family Table | 1 |
| • Added DDF and DSG pkgs to Thermal Table..... | 6 |

| Changes from Revision AA (September 2019) to Revision AB (December 2019) | Page |
|---|-------------|
| • Changed LM393B and LM2903B from Preview to Active status..... | 1 |
| • Added Family Comparison Table..... | 1 |

| Changes from Revision Z (October 2017) to Revision AA (September 2019) | Page |
|---|-------------|
| • Added "B" devices with various text changes throughout datasheet..... | 1 |
| • Deleted from Device Information old LM193 CDIP and LCCC package references and drawings. These are on the LM139-MIL data sheet..... | 1 |
| • Added "B" devices Thermal Information table..... | 6 |
| • Added "B" device electrical tables..... | 6 |
| • Added "B" device graphs | 13 |

5 Pin Configuration and Functions

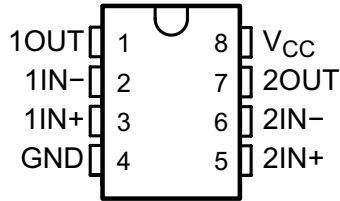
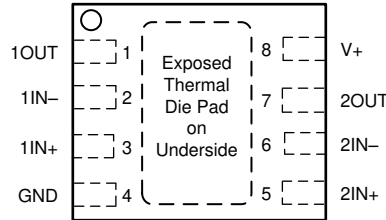

Figure 5-1. D, DGK, JG, P, PS, DDF or PW Package 8-Pin SOIC, VSSOP, PDIP, SO, or TSSOP Top View



Connect thermal pad directly to GND pin.

Figure 5-2. DSG Package 8-Pin WSON With Exposed Pad Top View

Table 5-1. Pin Functions

| NAME | PIN | | I/O | DESCRIPTION |
|-----------------|--------------------------------------|-----|--------|------------------------------------|
| | SOIC, VSSOP, PDIP, SO, DDF and TSSOP | DSG | | |
| 1OUT | 1 | 1 | Output | Output pin of comparator 1 |
| 1IN- | 2 | 2 | Input | Negative input pin of comparator 1 |
| 1IN+ | 3 | 3 | Input | Positive input pin of comparator 1 |
| GND | 4 | 4 | — | Ground |
| 2IN+ | 5 | 5 | Input | Positive input pin of comparator 2 |
| 2IN- | 6 | 6 | Input | Negative input pin of comparator 2 |
| 2OUT | 7 | 7 | Output | Output pin of comparator 2 |
| V _{CC} | 8 | 8 | — | Positive Supply |
| Thermal Pad | — | PAD | — | Connect directly to GND pin |

6 Specifications

6.1 Absolute Maximum Ratings

over operating free-air temperature range (unless otherwise noted) ⁽¹⁾

| | | MIN | MAX | UNIT |
|------------------|---|-----------------|-----|------|
| V _{CC} | Supply voltage ⁽²⁾ | Non-B Versions | 36 | V |
| | | B Versions Only | 38 | |
| V _{ID} | Differential input voltage ⁽³⁾ | Non-B Versions | 36 | V |
| | | B Versions Only | 38 | |
| V _I | Input voltage (either input) | Non-B Versions | 36 | V |
| | | B Versions Only | 38 | |
| I _{IK} | Input current ⁽⁵⁾ | -50 | | mA |
| V _O | Output voltage | Non-B Versions | 36 | V |
| | | B Versions Only | 38 | |
| I _O | Output current | Non-B Versions | 20 | mA |
| | | B Versions Only | 25 | |
| I _{SC} | Duration of output short circuit to ground ⁽⁴⁾ | Unlimited | | |
| T _J | Operating virtual-junction temperature | 150 | | °C |
| T _{stg} | Storage temperature | -65 | 150 | °C |

- (1) Stresses beyond those listed under *Absolute Maximum Ratings* may cause permanent damage to the device. These are stress ratings only, and functional operation of the device at these or any other conditions beyond those indicated under *Recommended Operating Conditions* is not implied. Exposure to absolute-maximum-rated conditions for extended periods may affect device reliability. Production Processing Does Not Necessarily Include Testing of All Parameters.
- (2) All voltage values, except differential voltages, are with respect to network ground.
- (3) Differential voltages are at IN+ with respect to IN-.
- (4) Short circuits from outputs to V_{CC} can cause excessive heating and eventual destruction.
- (5) Input current flows thorough parasitic diode to ground and turns on parasitic transistors that increases I_{CC} and may cause output to be incorrect. Normal operation resumes when input current is removed.

6.2 Recommended Operating Conditions

Over operating free-air temperature range (unless otherwise noted)

| | | MIN | MAX | UNIT |
|--|------------------------------------|------|------------|------|
| Supply voltage, V _S = (V+) – (V-) | non-V devices | 2 | 30 | V |
| | V devices | 2 | 32 | |
| | "B" version devices | 2 | 36 | |
| Input voltage range, V _{IVR} | non-B devices | 0 | (V+) – 2.0 | V |
| | "B" version devices | -0.1 | | |
| Ambient temperature, T _A | LM193 | -55 | 125 | °C |
| | LM2903, LM2903V, LM2903AV, LM2903B | -40 | 125 | |
| | LM393B | -40 | 85 | |
| | LM293, LM293A | -25 | 85 | |
| | LM393, LM393A | 0 | 70 | |

6.3 Thermal Information: LM193

| THERMAL METRIC ⁽¹⁾ | | LM193 | |
|-------------------------------|--|----------|------|
| | | D (SOIC) | UNIT |
| | | 8 pin | |
| R _{θJA} | Junction-to-ambient thermal resistance | 126.4 | °C/W |
| R _{θJC(top)} | Junction-to-case (top) thermal resistance | 70 | °C/W |
| R _{θJB} | Junction-to-board thermal resistance | 64.9 | °C/W |
| ψ _{JT} | Junction-to-top characterization parameter | 20.3 | °C/W |
| ψ _{JB} | Junction-to-board characterization parameter | 64.5 | °C/W |
| R _{θJC(bot)} | Junction-to-case (bottom) thermal resistance | n/a | °C/W |

(1) For more information about traditional and new thermal metrics, see the [Semiconductor and IC Package Thermal Metrics](#) report.

6.4 Thermal Information: LM293, LM393, LM2903 (all 'V' and 'A' suffixes)

| THERMAL METRIC ⁽¹⁾ | | LM293, LM393, LM2903 | | | | | UNIT |
|-------------------------------|--|----------------------|-------------|----------|---------|------------|------|
| | | D (SOIC) | DGK (VSSOP) | P (PDIP) | PS (SO) | PW (TSSOP) | |
| | | 8 pin | 8 pin | 8 pin | 8 pin | 8 pin | |
| R _{θJA} | Junction-to-ambient thermal resistance | 131.8 | 199.4 | 73.7 | 139 | 194.1 | °C/W |
| R _{θJC(top)} | Junction-to-case (top) thermal resistance | 78.4 | 90.2 | 62.6 | 98.9 | 77.0 | °C/W |
| R _{θJB} | Junction-to-board thermal resistance | 72.2 | 120.8 | 50.8 | 83.7 | 123.0 | °C/W |
| ψ _{JT} | Junction-to-top characterization parameter | 26.5 | 21.5 | 39.2 | 47.4 | 13.1 | °C/W |
| ψ _{JB} | Junction-to-board characterization parameter | 71.1 | 119.1 | 50.7 | 83 | 121.3 | °C/W |

(1) For more information about traditional and new thermal metrics, see the [Semiconductor and IC Package Thermal Metrics](#) report.

6.5 Thermal Information: LM393B and LM2903B

| THERMAL METRIC ⁽¹⁾ | | LM393B, LM2903B | | | | | UNIT |
|-------------------------------|--|-----------------|------------|-------------|--------------|------------|------|
| | | D (SOIC) | PW (TSSOP) | DGK (VSSOP) | DDF (SOT-23) | DSG (WSON) | |
| | | 8 pin | 8 pin | 8 pin | 8 pin | 8 pins | |
| R _{θJA} | Junction-to-ambient thermal resistance | 148.5 | 200.6 | 193.7 | 197.9 | 96.9 | °C/W |
| R _{θJC(top)} | Junction-to-case (top) thermal resistance | 90.2 | 89.6 | 82.9 | 119.2 | 119.0 | °C/W |
| R _{θJB} | Junction-to-board thermal resistance | 91.8 | 131.3 | 115.5 | 115.4 | 63.1 | °C/W |
| ψ _{JT} | Junction-to-top characterization parameter | 38.5 | 22.1 | 20.8 | 19.4 | 12.4 | °C/W |
| ψ _{JB} | Junction-to-board characterization parameter | 91.1 | 129.6 | 113.9 | 113.7 | 63.0 | °C/W |
| R _{θJC(bot)} | Junction-to-case (bottom) thermal resistance | - | - | - | - | 37.8 | °C/W |

(1) For more information about traditional and new thermal metrics, see the [Semiconductor and IC Package Thermal Metrics](#) report.

6.6 ESD Ratings

| | | VALUE | UNIT |
|--------------------------------|-------------------------|--|-------|
| LM393B and LM2903B Only | | | |
| V _(ESD) | Electrostatic discharge | Human body model (HBM), per ANSI/ESDA/JEDEC JS-001 ⁽¹⁾ | ±2000 |
| | | Charged-device model (CDM), per JEDEC specification JESD22-C101 ⁽²⁾ | ±1000 |
| All Other Versions | | | |
| V _(ESD) | Electrostatic discharge | Human body model (HBM), per ANSI/ESDA/JEDEC JS-001 ⁽¹⁾ | ±1000 |
| | | Charged-device model (CDM), per JEDEC specification JESD22-C101 ⁽²⁾ | ±750 |

- (1) JEDEC document JEP155 states that 500-V HBM allows safe manufacturing with a standard ESD control process.
 (2) JEDEC document JEP157 states that 250-V CDM allows safe manufacturing with a standard ESD control process.

6.7 Electrical Characteristics LM393B

$V_S = 5\text{ V}$, $V_{CM} = (V-)$; $T_A = 25^\circ\text{C}$ (unless otherwise noted).

| PARAMETER | | TEST CONDITIONS | MIN | TYP | MAX | UNIT |
|--------------|---|--|------|------------|------------|---------------|
| V_{IO} | Input offset voltage | $V_S = 5\text{ to }36\text{V}$ | -2.5 | ± 0.37 | 2.5 | mV |
| | | $V_S = 5\text{ to }36\text{V}$, $T_A = -40^\circ\text{C to }+85^\circ\text{C}$ | -4 | | 4 | |
| | Input offset voltage, DGK package only | $V_S = 5\text{ to }36\text{V}$ | -3.5 | ± 0.37 | 3.5 | |
| | | $V_S = 5\text{ to }36\text{V}$, $T_A = -40^\circ\text{C to }+85^\circ\text{C}$ | -5 | | 5 | |
| I_B | Input bias current | | | -3.5 | -25 | nA |
| | | $T_A = -40^\circ\text{C to }+85^\circ\text{C}$ | | | -50 | nA |
| I_{OS} | Input offset current | | -10 | ± 0.5 | 10 | nA |
| | | $T_A = -40^\circ\text{C to }+85^\circ\text{C}$ | -25 | | 25 | nA |
| V_{CM} | Common mode range (1) | $V_S = 3\text{ to }36\text{V}$ | (V-) | | (V+) - 1.5 | V |
| | | $V_S = 3\text{ to }36\text{V}$, $T_A = -40^\circ\text{C to }+85^\circ\text{C}$ | (V-) | | (V+) - 2.0 | V |
| A_{VD} | Large signal differential voltage amplification | $V_S = 15\text{V}$, $V_O = 1.4\text{V to }11.4\text{V}$; $R_L \geq 15\text{k to }(V+)$ | 50 | 200 | | V/mV |
| V_{OL} | Low level output Voltage {swing from (V-)} | $I_{SINK} \leq 4\text{mA}$, $V_{ID} = -1\text{V}$ | | 110 | 400 | mV |
| | | $I_{SINK} \leq 4\text{mA}$, $V_{ID} = -1\text{V}$ $T_A = -40^\circ\text{C to }+85^\circ\text{C}$ | | | 550 | mV |
| I_{OH-LKG} | High-level output leakage current | $(V+) = V_O = 5\text{ V}$; $V_{ID} = 1\text{V}$ | | 0.1 | 20 | nA |
| | | $(V+) = V_O = 36\text{V}$; $V_{ID} = 1\text{V}$ | | 0.3 | 50 | nA |
| I_{OL} | Low level output current | $V_{OL} = 1.5\text{V}$; $V_{ID} = -1\text{V}$; $V_S = 5\text{V}$ | 6 | 21 | | mA |
| I_Q | Quiescent current (all comparators) | $V_S = 5\text{ V}$, no load | | 400 | 600 | μA |
| | | $V_S = 36\text{ V}$, no load, $T_A = -40^\circ\text{C to }+85^\circ\text{C}$ | | 550 | 800 | μA |

- (1) The voltage at either input should not be allowed to go negative by more than 0.3 V otherwise output may be incorrect and excessive input current can flow. The upper end of the common-mode voltage range is limited by $V_{CC} - 2\text{V}$. However only one input needs to be in the valid common mode range, the other input can go up the maximum V_{CC} level and the comparator provides a proper output state. Either or both inputs can go to maximum V_{CC} level without damage.

6.8 Electrical Characteristics LM2903B

$V_S = 5\text{ V}$, $V_{CM} = (V-)$; $T_A = 25^\circ\text{C}$ (unless otherwise noted).

| PARAMETER | | TEST CONDITIONS | MIN | TYP | MAX | UNIT |
|--------------|---|---|------|------------|------------|---------------|
| V_{IO} | Input offset voltage | $V_S = 5\text{ to }36\text{V}$ | -2.5 | ± 0.37 | 2.5 | mV |
| | | $V_S = 5\text{ to }36\text{V}$, $T_A = -40^\circ\text{C to }+125^\circ\text{C}$ | -4 | | 4 | |
| | Input offset voltage, DGK package only | $V_S = 5\text{ to }36\text{V}$ | -3.5 | ± 0.37 | 3.5 | |
| | | $V_S = 5\text{ to }36\text{V}$, $T_A = -40^\circ\text{C to }+125^\circ\text{C}$ | -5 | | 5 | |
| I_B | Input bias current | | | -3.5 | -25 | nA |
| | | $T_A = -40^\circ\text{C to }+125^\circ\text{C}$ | | | | -50 |
| I_{OS} | Input offset current | | -10 | ± 0.5 | 10 | nA |
| | | $T_A = -40^\circ\text{C to }+125^\circ\text{C}$ | | | | -25 |
| V_{CM} | Common mode range (1) | $V_S = 3\text{ to }36\text{V}$ | (V-) | | (V+) - 1.5 | V |
| | | $V_S = 3\text{ to }36\text{V}$, $T_A = -40^\circ\text{C to }+125^\circ\text{C}$ | (V-) | | (V+) - 2.0 | V |
| A_{VD} | Large signal differential voltage amplification | $V_S = 15\text{V}$, $V_O = 1.4\text{V to }11.4\text{V}$; $R_L \geq 15\text{k to } (V+)$ | 50 | 200 | | V/mV |
| V_{OL} | Low level output Voltage {swing from (V-)} | $I_{SINK} \leq 4\text{mA}$, $V_{ID} = -1\text{V}$ | | 110 | 400 | mV |
| | | $I_{SINK} \leq 4\text{mA}$, $V_{ID} = -1\text{V}$ $T_A = -40^\circ\text{C to }+125^\circ\text{C}$ | | | 550 | mV |
| I_{OH-LKG} | High-level output leakage current | (V+) = $V_O = 5\text{ V}$; $V_{ID} = 1\text{V}$ | | 0.1 | 20 | nA |
| | | (V+) = $V_O = 36\text{V}$; $V_{ID} = 1\text{V}$ | | 0.3 | 50 | nA |
| I_{OL} | Low level output current | $V_{OL} = 1.5\text{V}$; $V_{ID} = -1\text{V}$; $V_S = 5\text{V}$ | 6 | 21 | | mA |
| I_Q | Quiescent current (all comparators) | $V_S = 5\text{ V}$, no load | | 400 | 600 | μA |
| | | $V_S = 36\text{ V}$, no load, $T_A = -40^\circ\text{C to }+125^\circ\text{C}$ | | 550 | 800 | μA |

- (1) The voltage at either input should not be allowed to go negative by more than 0.3 V otherwise output may be incorrect and excessive input current can flow. The upper end of the common-mode voltage range is limited by $V_{CC} - 2\text{V}$. However only one input needs to be in the valid common mode range, the other input can go up the maximum V_{CC} level and the comparator provides a proper output state. Either or both inputs can go to maximum V_{CC} level without damage.

6.9 Switching Characteristics LM393B and LM2903B

$V_S = 5\text{V}$, $V_O\text{ PULLUP} = 5\text{V}$, $V_{CM} = V_S/2$, $C_L = 15\text{pF}$, $R_L = 5.1\text{k Ohm}$, $T_A = 25^\circ\text{C}$ (unless otherwise noted).

| PARAMETER | | TEST CONDITIONS | MIN | TYP | MAX | UNIT |
|-----------------------|---|---|-----|------|-----|------|
| t_{response} | Propagation delay time, high-to-low; TTL input signal (1) | TTL input with $V_{\text{ref}} = 1.4\text{V}$ | | 300 | | ns |
| t_{response} | Propagation delay time, high-to-low; Small scale input signal (1) | Input overdrive = 5mV, Input step = 100mV | | 1000 | | ns |

- (1) High-to-low and low-to-high refers to the transition at the input.

6.10 Electrical Characteristics for LM193, LM293, and LM393 (without A suffix)

at specified free-air temperature, $V_{CC} = 5\text{ V}$ (unless otherwise noted)

| PARAMETER | TEST CONDITIONS | T_A ⁽¹⁾ | LM193 | | | LM293 LM393 | | | UNIT | |
|--|--|------------------------|------------|------------------------|------|----------------|------------------------|------|---------------|----|
| | | | MIN | TYP | MAX | MIN | TYP | MAX | | |
| V_{IO} Input offset voltage | $V_{CC} = 5\text{ V to }30\text{ V}$, $V_{IC} = V_{ICR}\text{ min}$, $V_O = 1.4\text{ V}$ | 25°C | | 2 | 5 | | 2 | 5 | mV | |
| | | Full range | | | 9 | | | 9 | | |
| I_{IO} Input offset current | $V_O = 1.4\text{ V}$ | 25°C | | 3 | 25 | | 5 | 50 | nA | |
| | | Full range | | | 100 | | | 250 | | |
| I_{IB} Input bias current | $V_O = 1.4\text{ V}$ | 25°C | | -25 | -100 | | -25 | -250 | nA | |
| | | Full range | | | -300 | | | -400 | | |
| V_{ICR} Common-mode input-voltage range ⁽²⁾ | | 25°C | | 0 to $V_{CC} - 1.5$ | | | 0 to $V_{CC} - 1.5$ | | V | |
| | | Full range | | 0 to $V_{CC} - 2$ | | | 0 to $V_{CC} - 2$ | | | |
| A_{VD} Large-signal differential-voltage amplification | $V_{CC} = 15\text{ V}$, $V_O = 1.4\text{ V to }11.4\text{ V}$, $R_L \geq 15\text{ k}\Omega\text{ to }V_{CC}$ | 25°C | | 50 | 200 | | 50 | 200 | V/mV | |
| I_{OH} High-level output current | $V_{OH} = 5\text{ V}$ | $V_{ID} = 1\text{ V}$ | 25°C | | 0.1 | | 0.1 | 50 | nA | |
| | $V_{OH} = 30\text{ V}$ | $V_{ID} = 1\text{ V}$ | Full range | | | 1 | | 1 | μA | |
| V_{OL} Low-level output voltage | $I_{OL} = 4\text{ mA}$, $V_{ID} = -1\text{ V}$ | 25°C | | 150 | 400 | | 130 | 400 | mV | |
| | | Full range | | | 700 | | | 700 | | |
| I_{OL} Low-level output current | $V_{OL} = 1.5\text{ V}$, $V_{ID} = -1\text{ V}$ | 25°C | | 6 | | | 6 | | mA | |
| I_{CC} Supply current | $R_L = \infty$ | $V_{CC} = 5\text{ V}$ | 25°C | | 0.8 | 1 | | 0.45 | 1 | mA |
| | | $V_{CC} = 30\text{ V}$ | Full range | | | 2.5 | | 0.55 | 2.5 | |

- (1) Full range (minimum or maximum) for LM193 is -55°C to 125°C , for LM293 is -25°C to 85°C , and for LM393 is 0°C to 70°C . All characteristics are measured with zero common-mode input voltage, unless otherwise specified.
- (2) The voltage at either input should not be allowed to go negative by more than 0.3 V otherwise output may be incorrect and excessive input current can flow. The upper end of the common-mode voltage range is limited by $V_{CC} - 2\text{V}$. However only one input needs to be in the valid common mode range, the other input can go up the maximum V_{CC} level and the comparator provides a proper output state. Either or both inputs can go to maximum V_{CC} level without damage.

6.11 Electrical Characteristics for LM293A and LM393A

at specified free-air temperature, $V_{CC} = 5\text{ V}$ (unless otherwise noted)

| PARAMETER | TEST CONDITIONS | T_A ⁽¹⁾ | LM293A LM393A | | | UNIT |
|--|--|------------------------|------------------|---------------------|------|---------------|
| | | | MIN | TYP | MAX | |
| V_{IO} Input offset voltage | $V_{CC} = 5\text{ V to }30\text{ V}$, $V_O = 1.4\text{ V}$ $V_{IC} = V_{ICR(min)}$ | 25°C | | 1 | 2 | mV |
| | | Full range | | | 4 | |
| I_{IO} Input offset current | $V_O = 1.4\text{ V}$ | 25°C | | 5 | 50 | nA |
| | | Full range | | | 150 | |
| I_{IB} Input bias current | $V_O = 1.4\text{ V}$ | 25°C | | -25 | -250 | nA |
| | | Full range | | | -400 | |
| V_{ICR} Common-mode input-voltage range ⁽²⁾ | | 25°C | | 0 to $V_{CC} - 1.5$ | | V |
| | | Full range | | 0 to $V_{CC} - 2$ | | |
| A_{VD} Large-signal differential-voltage amplification | $V_{CC} = 15\text{ V}$, $V_O = 1.4\text{ V to }11.4\text{ V}$, $R_L \geq 15\text{ k}\Omega$ to V_{CC} | 25°C | | 50 | 200 | V/mV |
| I_{OH} High-level output current | $V_{OH} = 5\text{ V}$, $V_{ID} = 1\text{ V}$ | 25°C | | 0.1 | 50 | nA |
| | $V_{OH} = 30\text{ V}$, $V_{ID} = 1\text{ V}$ | Full range | | | 1 | μA |
| V_{OL} Low-level output voltage | $I_{OL} = 4\text{ mA}$, $V_{ID} = -1\text{ V}$ | 25°C | | 110 | 400 | mV |
| | | Full range | | | 700 | |
| I_{OL} Low-level output current | $V_{OL} = 1.5\text{ V}$, $V_{ID} = -1\text{ V}$ | 25°C | | 6 | | mA |
| I_{CC} Supply current | $R_L = \infty$ | $V_{CC} = 5\text{ V}$ | 25°C | 0.60 | 1 | mA |
| | | $V_{CC} = 30\text{ V}$ | Full range | 0.72 | 2.5 | |

- (1) Full range (minimum or maximum) for LM293A is -25°C to 85°C , and for LM393A is 0°C to 70°C . All characteristics are measured with zero common-mode input voltage, unless otherwise specified.
- (2) The voltage at either input should not be allowed to go negative by more than 0.3 V otherwise output may be incorrect and excessive input current can flow. The upper end of the common-mode voltage range is limited by $V_{CC} - 2\text{V}$. However only one input needs to be in the valid common mode range, the other input can go up the maximum V_{CC} level and the comparator provides a proper output state. Either or both inputs can go to maximum V_{CC} level without damage.

6.12 Electrical Characteristics for LM2903, LM2903V, and LM2903AV

at specified free-air temperature, $V_{CC} = 5\text{ V}$ (unless otherwise noted)

| PARAMETER | TEST CONDITIONS | T_A ⁽¹⁾ | LM2903, LM2903V | | | LM2903AV | | | UNIT | |
|--|---|-----------------------|-----------------|------------------------|------|------------------------|-----|------|------|---------------|
| | | | MIN | TYP | MAX | MIN | TYP | MAX | | |
| V_{IO} Input offset voltage | $V_{CC} = 5\text{ V to MAX}^{(2)}$, $V_O = 1.4\text{ V}$, $V_{IC} = V_{ICR(min)}$ | 25°C | | 2 | 7 | | 1 | 2 | mV | |
| | | Full range | | | 15 | | | 4 | | |
| I_{IO} Input offset current | $V_O = 1.4\text{ V}$ | 25°C | | 5 | 50 | | 5 | 50 | nA | |
| | | Full range | | | 200 | | | 200 | | |
| I_{IB} Input bias current | $V_O = 1.4\text{ V}$ | 25°C | | -25 | -250 | | -25 | -250 | nA | |
| | | Full range | | | -500 | | | -500 | | |
| V_{ICR} Common-mode input-voltage range ⁽³⁾ | | 25°C | | 0 to $V_{CC} - 1.5$ | | 0 to $V_{CC} - 1.5$ | | | V | |
| | | Full range | | 0 to $V_{CC} - 2$ | | 0 to $V_{CC} - 2$ | | | | |
| A_{VD} Large-signal differential-voltage amplification | $V_{CC} = 15\text{ V}$, $V_O = 1.4\text{ V to } 11.4\text{ V}$, $R_L \geq 15\text{ k}\Omega\text{ to } V_{CC}$ | 25°C | | 25 | 100 | | 25 | 100 | V/mV | |
| I_{OH} High-level output current | $V_{OH} = 5\text{ V}$, $V_{ID} = 1\text{ V}$ | 25°C | | | 0.1 | 50 | | 0.1 | 50 | nA |
| | $V_{OH} = V_{CC}\text{ MAX}^{(2)}$, $V_{ID} = 1\text{ V}$ | Full range | | | | 1 | | | 1 | μA |
| V_{OL} Low-level output voltage | $I_{OL} = 4\text{ mA}$, $V_{ID} = -1\text{ V}$ | 25°C | | | 150 | 400 | | 150 | 400 | mV |
| | | Full range | | | | 700 | | | 700 | |
| I_{OL} Low-level output current | $V_{OL} = 1.5\text{ V}$, $V_{ID} = -1\text{ V}$ | 25°C | | | 6 | | | 6 | mA | |
| I_{CC} Supply current | $R_L = \infty$ | $V_{CC} = 5\text{ V}$ | 25°C | | | 0.8 | | 0.8 | 1 | mA |
| | | $V_{CC} = \text{MAX}$ | Full range | | | | 2.5 | | | |

- (1) Full range (minimum or maximum) for LM2903 is -40°C to 125°C . All characteristics are measured with zero common-mode input voltage, unless otherwise specified.
- (2) $V_{CC}\text{ MAX} = 30\text{ V}$ for non-V devices and 32 V for V-suffix devices.
- (3) The voltage at either input should not be allowed to go negative by more than 0.3 V otherwise output may be incorrect and excessive input current can flow. The upper end of the common-mode voltage range is limited by $V_{CC} - 2\text{ V}$. However only one input needs to be in the valid common mode range, the other input can go up the maximum V_{CC} level and the comparator provides a proper output state. Either or both inputs can go to maximum V_{CC} level without damage.

6.13 Switching Characteristics: LM193, LM239, LM393, LM2903, all 'A' and 'V' versions

$V_{CC} = 5\text{ V}$, $T_A = 25^\circ\text{C}$

| PARAMETER | TEST CONDITIONS | TYP | UNIT | |
|---------------|---|---------------------------------------|------|---------------|
| Response time | R_L connected to 5 V through $5.1\text{ k}\Omega$, $C_L = 15\text{ pF}^{(1)(2)}$ | 100-mV input step with 5-mV overdrive | 1.3 | μs |
| | | TTL-level input step | 0.3 | |

- (1) C_L includes probe and jig capacitance.
- (2) The response time specified is the interval between the input step function and the instant when the output crosses 1.4 V .

6.14 Typical Characteristics, LMx93, LM2903 (all 'V' and 'A' suffixes)

$T_A = 25^\circ\text{C}$, $V_S = 5\text{V}$, $R_{\text{PULLUP}} = 5.1\text{k}$, $C_L = 15\text{pF}$, $V_{\text{CM}} = 0\text{V}$ unless otherwise noted.

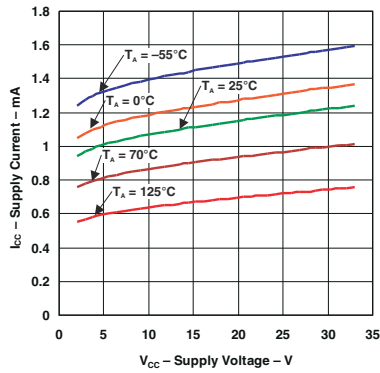

Figure 6-1. Supply Current vs Supply Voltage

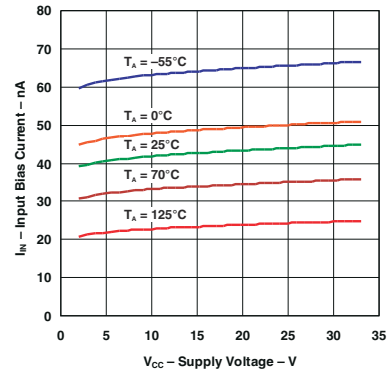

Figure 6-2. Input Bias Current vs Supply Voltage

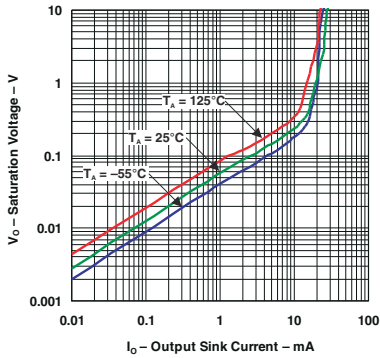

Figure 6-3. Output Saturation Voltage

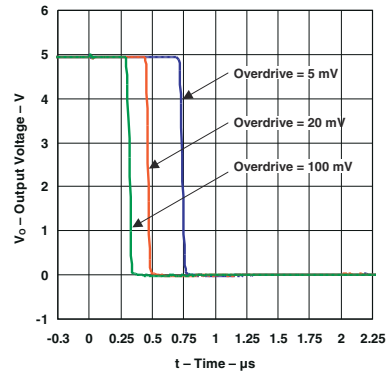

Figure 6-4. Response Time for Various Overdrives Negative Transition

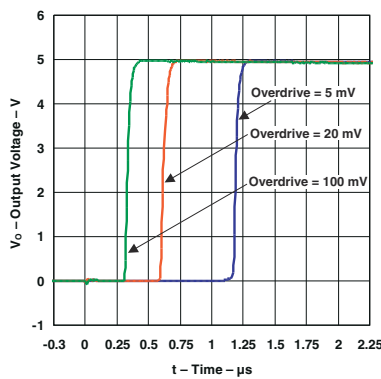

Figure 6-5. Response Time for Various Overdrives Positive Transition

6.15 Typical Characteristics, LM393B and LM2903B

$T_A = 25^\circ\text{C}$, $V_S = 5\text{ V}$, $R_{\text{PULLUP}} = 5.1\text{ k}$, $C_L = 15\text{ pF}$, $V_{\text{CM}} = 0\text{ V}$, $V_{\text{UNDERDRIVE}} = 100\text{ mV}$, $V_{\text{OVERDRIVE}} = 100\text{ mV}$ unless otherwise noted.

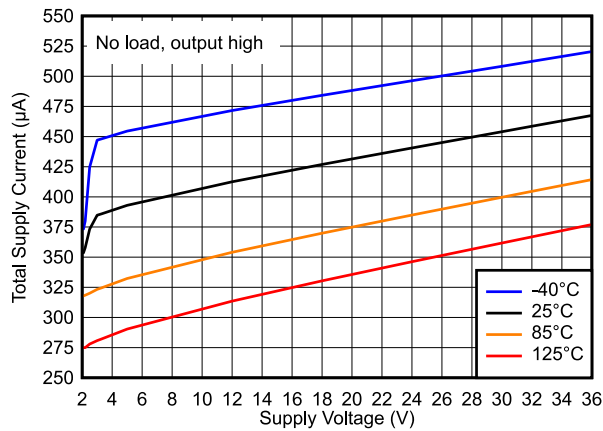

Figure 6-6. Total Supply Current vs. Supply Voltage

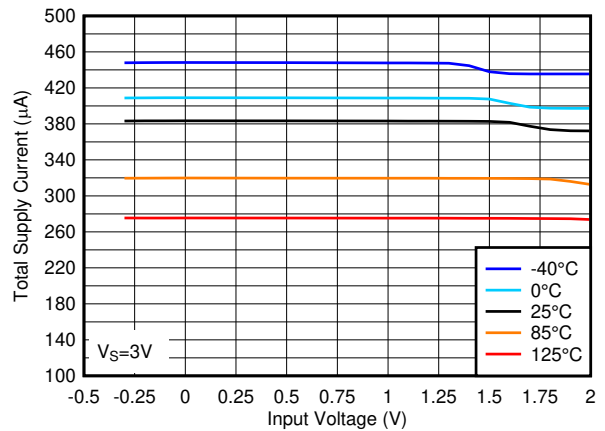

Figure 6-7. Total Supply Current vs. Input Voltage at 3V

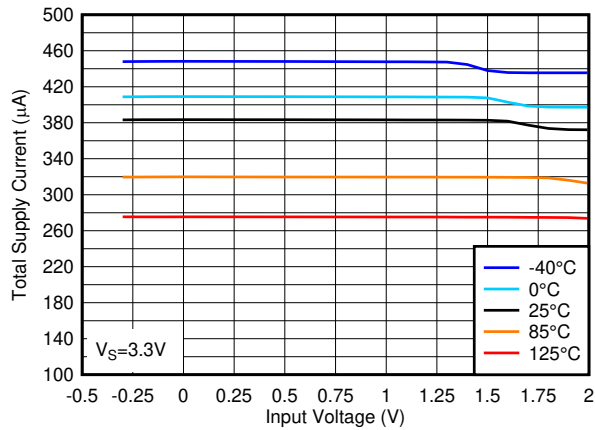

Figure 6-8. Total Supply Current vs. Input Voltage at 3.3V

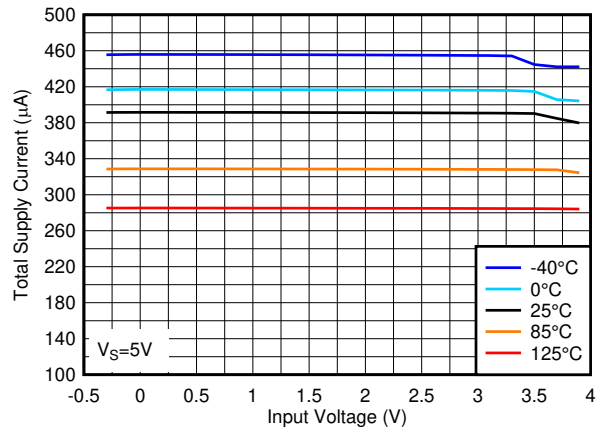

Figure 6-9. Total Supply Current vs. Input Voltage at 5V

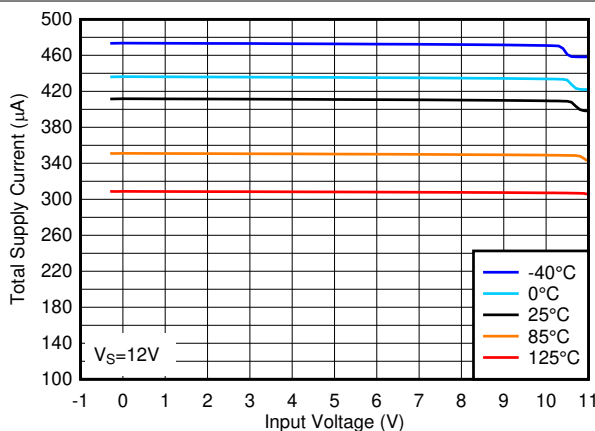

Figure 6-10. Total Supply Current vs. Input Voltage at 12V

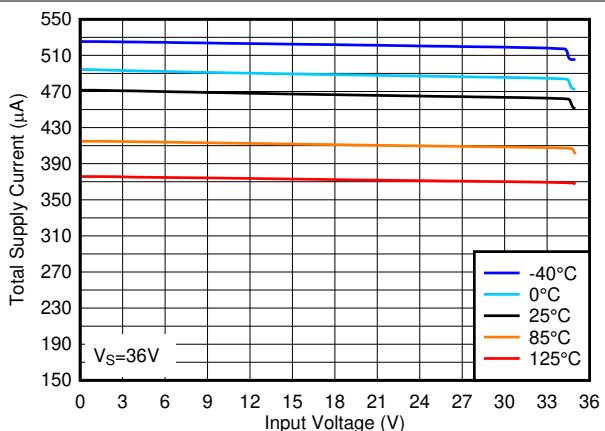

Figure 6-11. Total Supply Current vs. Input Voltage at 36V

6.15 Typical Characteristics, LM393B and LM2903B (continued)

$T_A = 25^\circ\text{C}$, $V_S = 5\text{ V}$, $R_{\text{PULLUP}} = 5.1\text{ k}$, $C_L = 15\text{ pF}$, $V_{\text{CM}} = 0\text{ V}$, $V_{\text{UNDERDRIVE}} = 100\text{ mV}$, $V_{\text{OVERDRIVE}} = 100\text{ mV}$ unless otherwise noted.

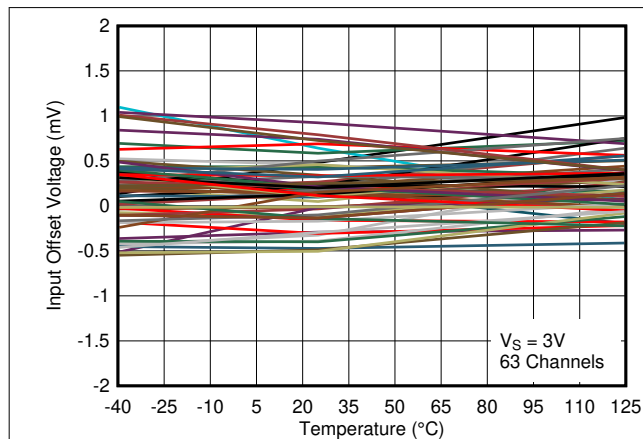

Figure 6-12. Input Offset Voltage vs. Temperature at 3V

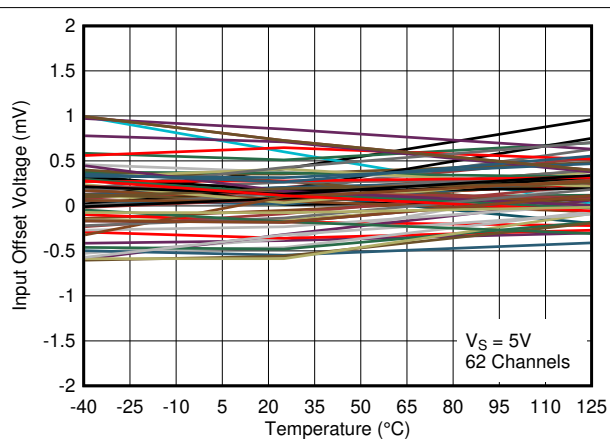

Figure 6-13. Input Offset Voltage vs. Temperature at 5V

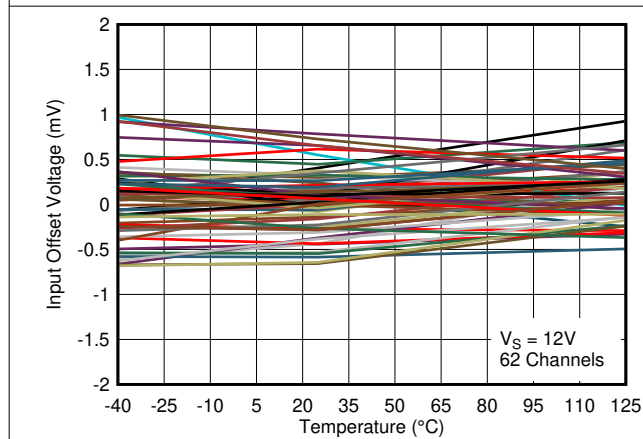

Figure 6-14. Input Offset Voltage vs. Temperature at 12V

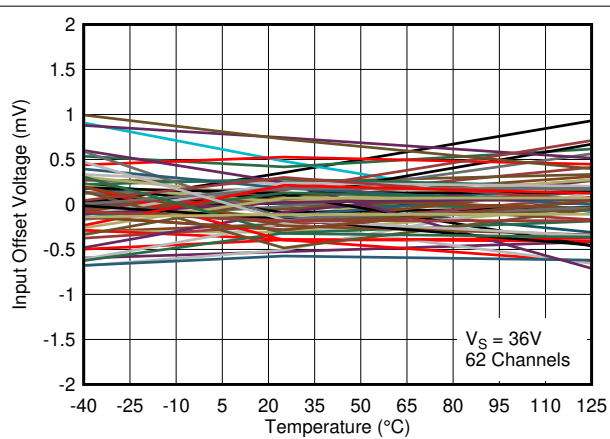

Figure 6-15. Input Offset Voltage vs. Temperature at 36V

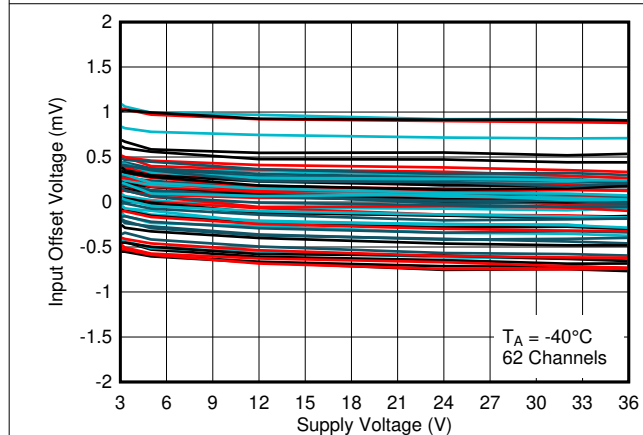

Figure 6-16. Input Offset Voltage vs. Supply Voltage at -40°C

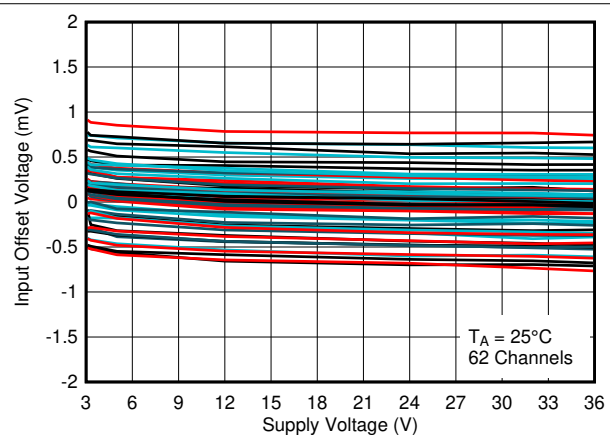

Figure 6-17. Input Offset Voltage vs. Supply Voltage at 25°C

6.15 Typical Characteristics, LM393B and LM2903B (continued)

$T_A = 25^\circ\text{C}$, $V_S = 5\text{ V}$, $R_{\text{PULLUP}} = 5.1\text{ k}$, $C_L = 15\text{ pF}$, $V_{\text{CM}} = 0\text{ V}$, $V_{\text{UNDERDRIVE}} = 100\text{ mV}$, $V_{\text{OVERDRIVE}} = 100\text{ mV}$ unless otherwise noted.

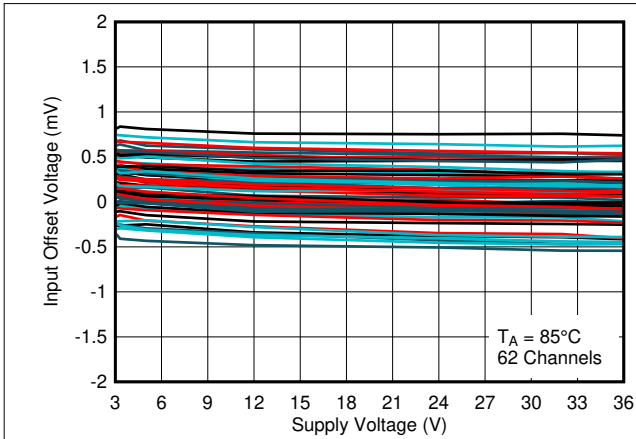

Figure 6-18. Input Offset Voltage vs. Supply Voltage at 85°C

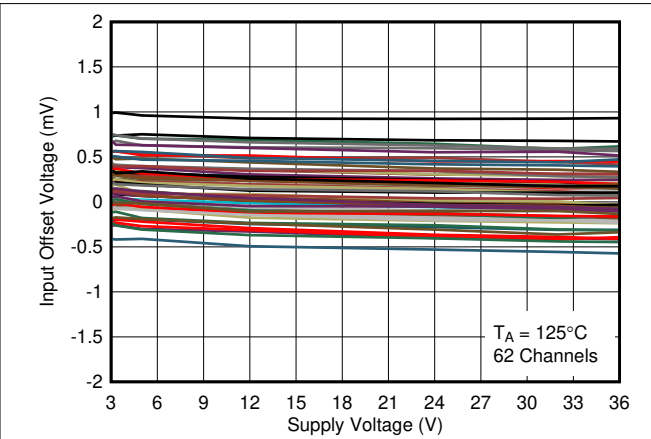

Figure 6-19. Input Offset Voltage vs. Supply Voltage at 125°C

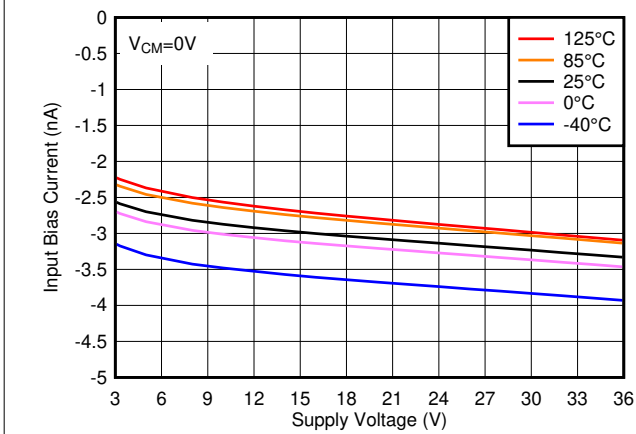

Figure 6-20. Input Bias Current vs. Supply Voltage

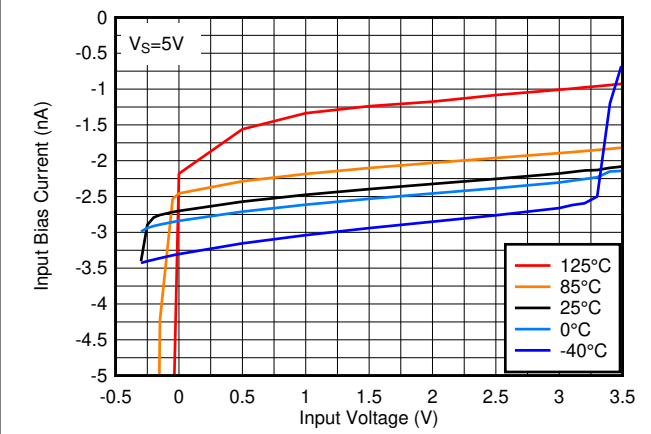

Figure 6-21. Input Bias Current vs. Input Voltage at 5V

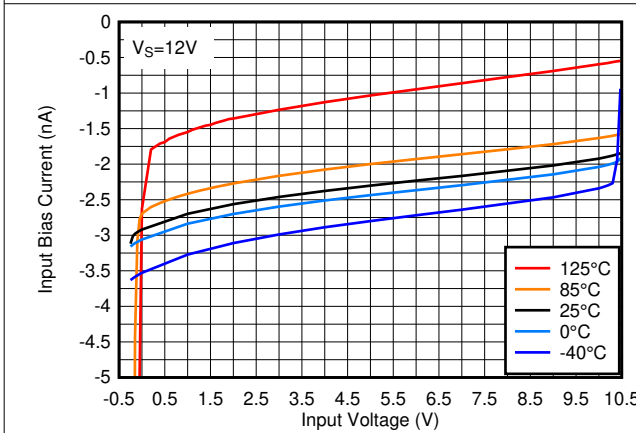

Figure 6-22. Input Bias Current vs. Input Voltage at 12V

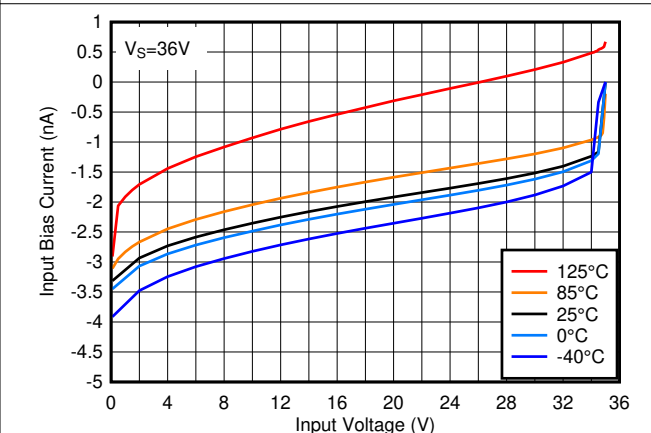

Figure 6-23. Input Bias Current vs. Input Voltage at 36V

6.15 Typical Characteristics, LM393B and LM2903B (continued)

$T_A = 25^\circ\text{C}$, $V_S = 5\text{ V}$, $R_{\text{PULLUP}} = 5.1\text{ k}$, $C_L = 15\text{ pF}$, $V_{\text{CM}} = 0\text{ V}$, $V_{\text{UNDERDRIVE}} = 100\text{ mV}$, $V_{\text{OVERDRIVE}} = 100\text{ mV}$ unless otherwise noted.

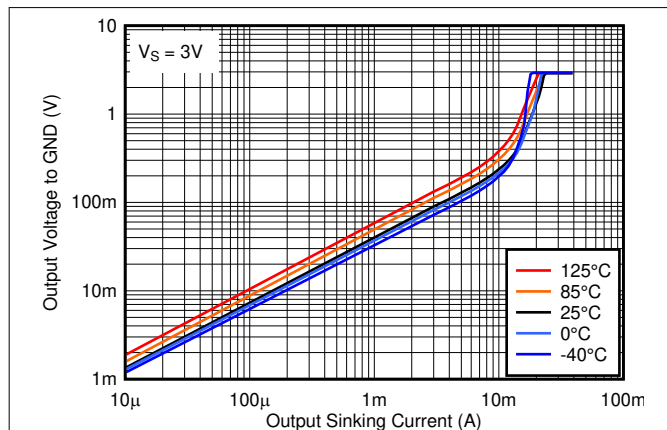

Figure 6-24. Output Low Voltage vs. Output Sinking Current at 3V

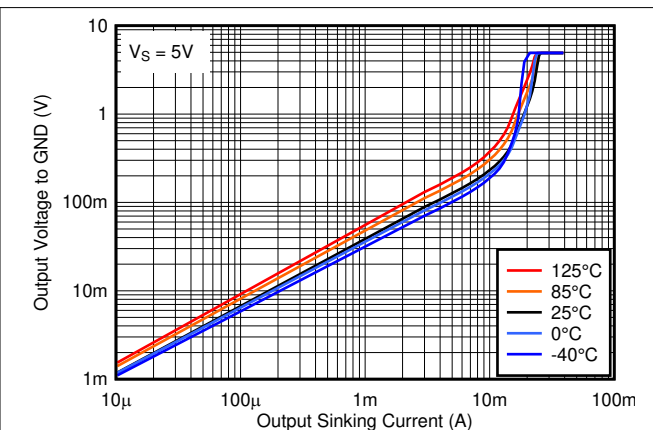

Figure 6-25. Output Low Voltage vs. Output Sinking Current at 5V

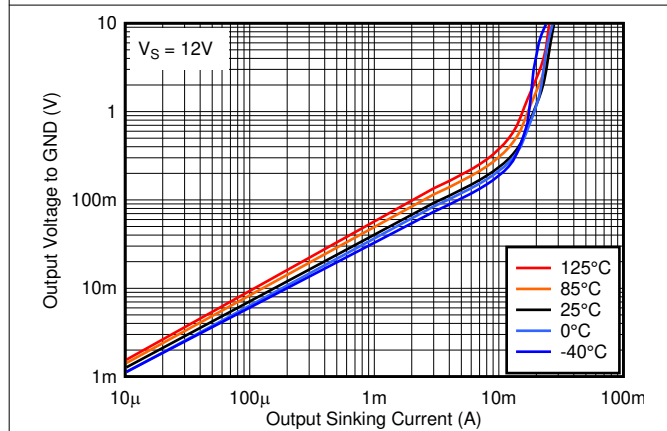

Figure 6-26. Output Low Voltage vs. Output Sinking Current at 12V

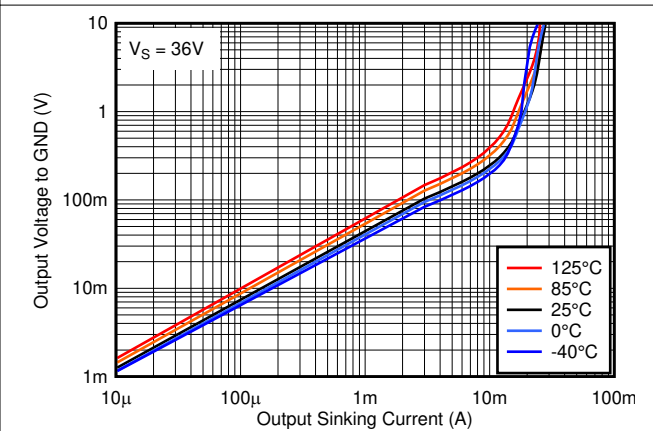

Figure 6-27. Output Low Voltage vs. Output Sinking Current at 36V

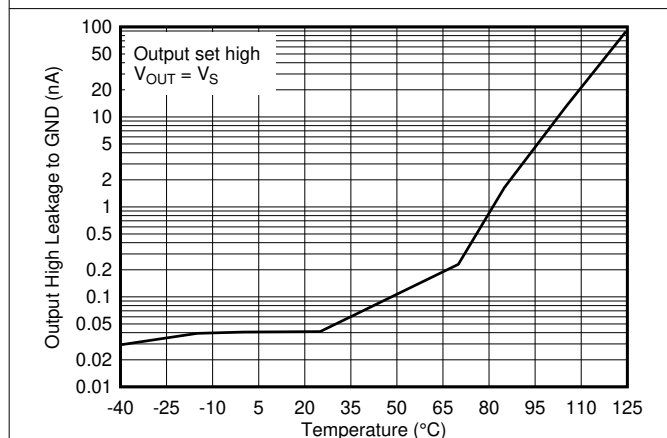

Figure 6-28. Output High Leakage Current vs. Temperature at 5V

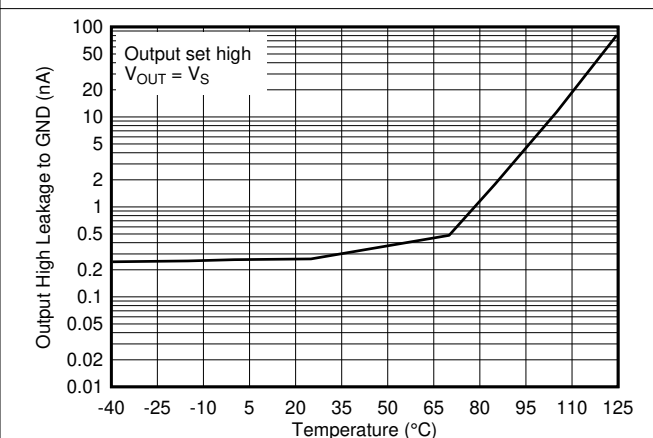

Figure 6-29. Output High Leakage Current vs. Temperature at 36V

6.15 Typical Characteristics, LM393B and LM2903B (continued)

$T_A = 25^\circ\text{C}$, $V_S = 5\text{ V}$, $R_{PULLUP} = 5.1\text{ k}$, $C_L = 15\text{ pF}$, $V_{CM} = 0\text{ V}$, $V_{UNDERDRIVE} = 100\text{ mV}$, $V_{OVERDRIVE} = 100\text{ mV}$ unless otherwise noted.

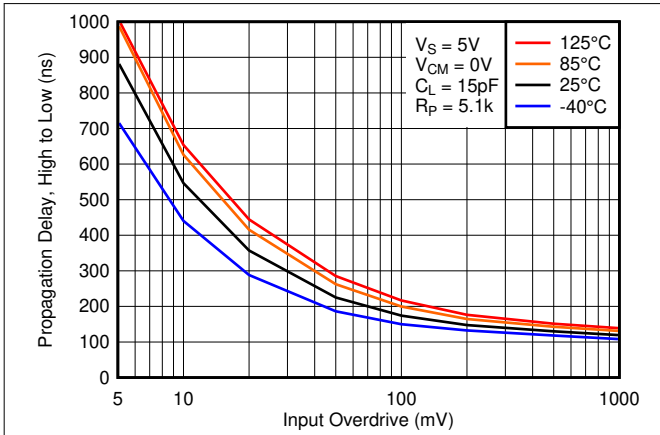

Figure 6-30. High to Low Propagation Delay vs. Input Overdrive Voltage, 5V

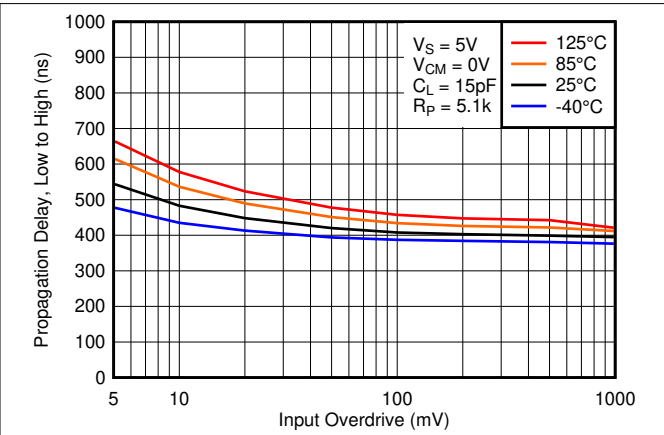

Figure 6-31. Low to High Propagation Delay vs. Input Overdrive Voltage, 5V

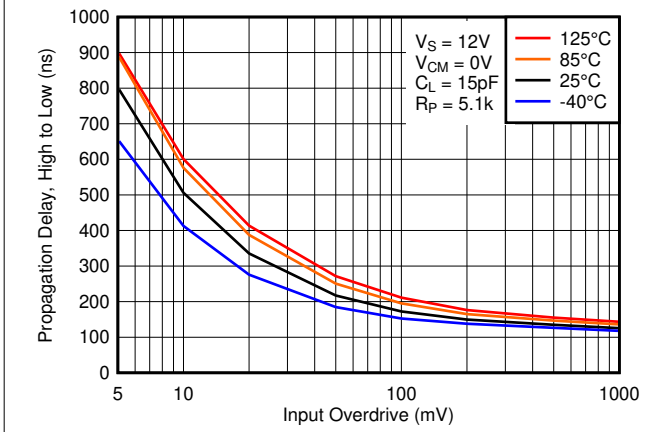

Figure 6-32. High to Low Propagation Delay vs. Input Overdrive Voltage, 12V

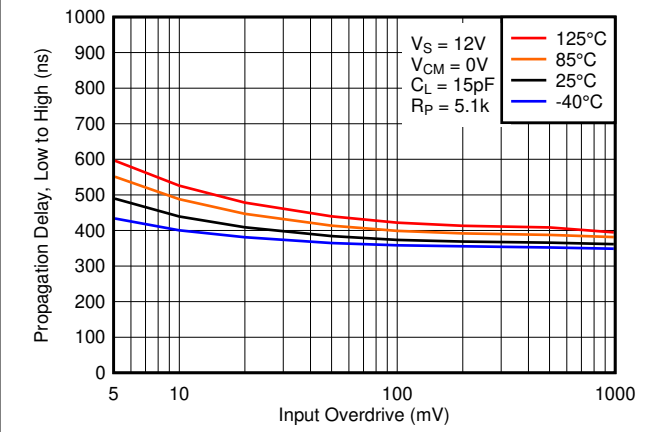

Figure 6-33. Low to High Propagation Delay vs. Input Overdrive Voltage, 12V

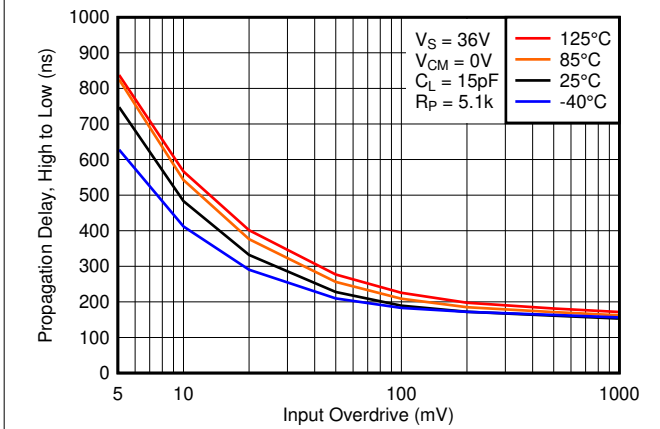

Figure 6-34. High to Low Propagation Delay vs. Input Overdrive Voltage, 36V

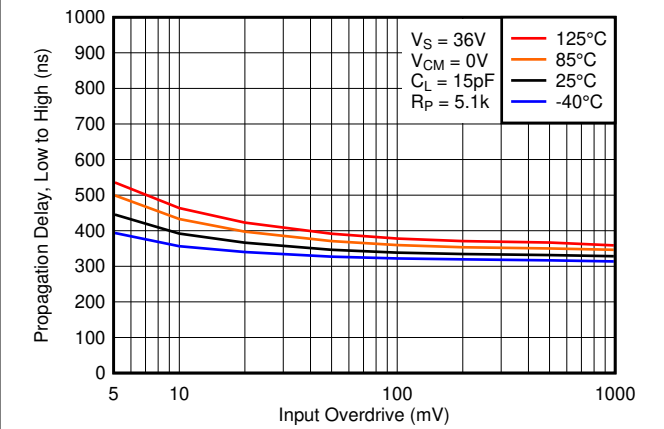

Figure 6-35. Low to High Propagation Delay vs. Input Overdrive Voltage, 36V

6.15 Typical Characteristics, LM393B and LM2903B (continued)

$T_A = 25^\circ\text{C}$, $V_S = 5\text{ V}$, $R_{\text{PULLUP}} = 5.1\text{ k}$, $C_L = 15\text{ pF}$, $V_{\text{CM}} = 0\text{ V}$, $V_{\text{UNDERDRIVE}} = 100\text{ mV}$, $V_{\text{OVERDRIVE}} = 100\text{ mV}$ unless otherwise noted.

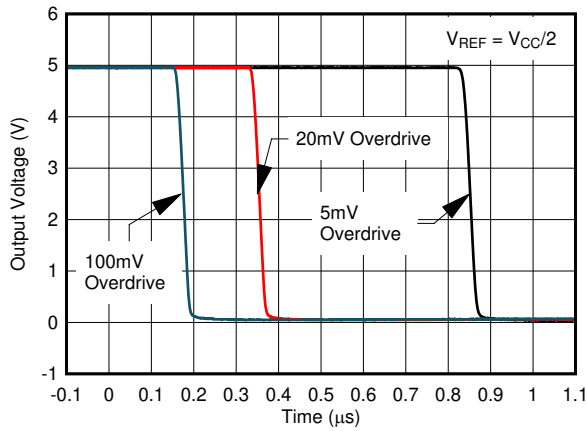

Figure 6-36. Response Time for Various Overdrives, High-to-Low Transition

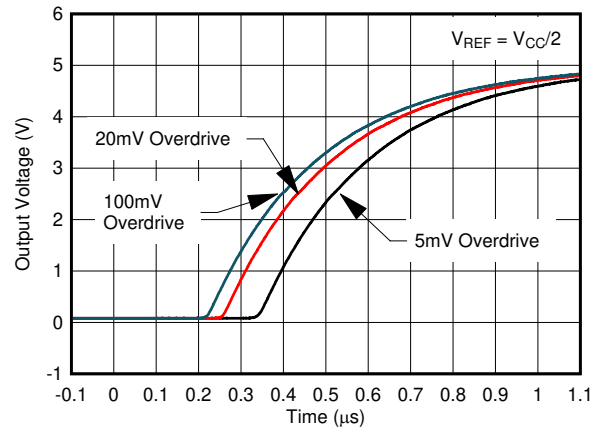

Figure 6-37. Response Time for Various Overdrives, Low-to-High Transition

7 Detailed Description

7.1 Overview

These dual comparators have the ability to operate up to absolute maximum of 36 V (38 V for the "B" version) on the supply pin. This device has proven ubiquity and versatility across a wide range of applications. This is due to very wide supply voltages range, low Iq and fast response of the devices.

The open-drain output allows the user to configure the output's logic high voltage (V_{OH}) and can be used to enable the comparator to be used in AND functionality.

7.2 Functional Block Diagram

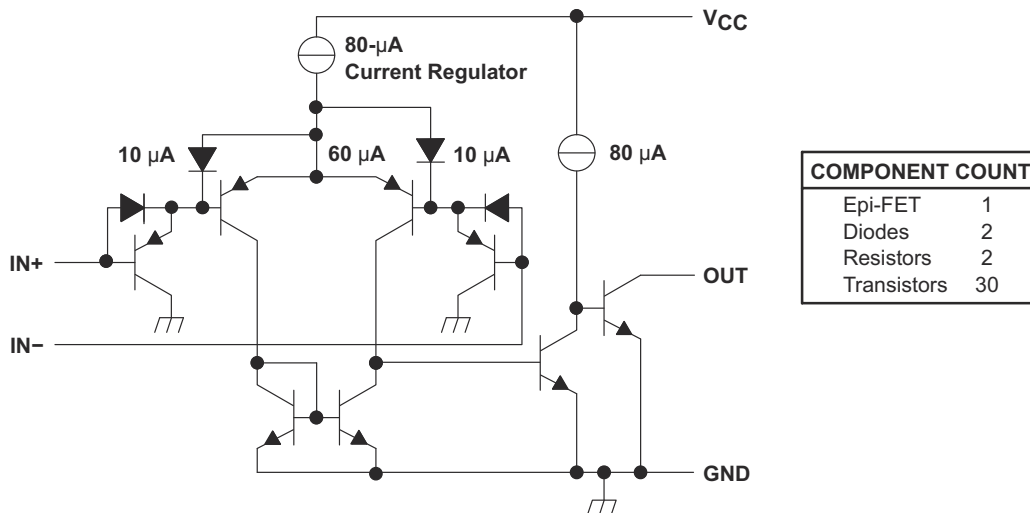

Figure 7-1. Schematic (Each Comparator)

7.3 Feature Description

The comparator consists of a PNP darlington pair input, allowing the device to operate with very high gain and fast response with minimal input bias current. The input Darlington pair creates a limit on the input common mode voltage capability, allowing the comparator to accurately function from ground to $V_{CC} - 1.5$ V input. Allow for $V_{CC} - 2$ V at cold temperature.

The output consists of an open drain NPN (pull-down or low side) transistor. The output NPN sinks current when the negative input voltage is higher than the positive input voltage and the offset voltage. The V_{OL} is resistive and scales with the output current. See Figure 6-3 for V_{OL} values with respect to the output current.

7.4 Device Functional Modes

7.4.1 Voltage Comparison

The device operates solely as a voltage comparator, comparing the differential voltage between the positive and negative pins and outputting a logic low or high impedance (logic high with pullup) based on the input differential polarity.

8 Application and Implementation

Note

Information in the following applications sections is not part of the TI component specification, and TI does not warrant its accuracy or completeness. TI's customers are responsible for determining suitability of components for their purposes, as well as validating and testing their design implementation to confirm system functionality.

8.1 Application Information

The device is typically used to compare a single signal to a reference or two signals against each other. Many users take advantage of the open drain output to drive the comparison logic output to a logic voltage level to an MCU or logic device. The wide supply range and high voltage capability makes this comparator optimal for level shifting to a higher or lower voltage.

8.2 Typical Application

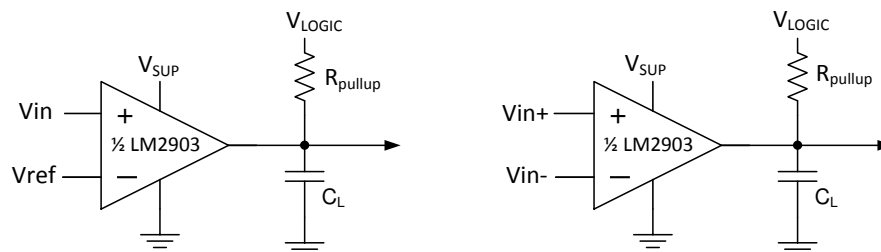

Figure 8-1. Single-Ended and Differential Comparator Configurations

8.2.1 Design Requirements

For this design example, use the parameters listed in [Table 8-1](#) as the input parameters.

Table 8-1. Design Parameters

| DESIGN PARAMETER | EXAMPLE VALUE |
|---------------------------------|---------------------------|
| Input Voltage Range | 0 V to $V_{sup}-2$ V |
| Supply Voltage | 4.5 V to V_{CC} maximum |
| Logic Supply Voltage | 0 V to V_{CC} maximum |
| Output Current (R_{PULLUP}) | 1 μ A to 4 mA |
| Input Overdrive Voltage | 100 mV |
| Reference Voltage | 2.5 V |
| Load Capacitance (C_L) | 15 pF |

8.2.2 Detailed Design Procedure

When using the device in a general comparator application, determine the following:

- Input Voltage Range
- Minimum Overdrive Voltage
- Output and Drive Current
- Response Time

8.2.2.1 Input Voltage Range

When choosing the input voltage range, the input common mode voltage range (V_{ICR}) must be taken in to account. If temperature operation is below 25°C the V_{ICR} can range from 0 V to $V_{CC}-2.0$ V. This limits the input

voltage range to as high as $V_{CC} - 2.0\text{ V}$ and as low as 0 V. Operation outside of this range can yield incorrect comparisons.

The following is a list of input voltage situation and their outcomes:

1. When both IN- and IN+ are both within the common-mode range:
 - a. If IN- is higher than IN+ and the offset voltage, the output is low and the output transistor is sinking current
 - b. If IN- is lower than IN+ and the offset voltage, the output is high impedance and the output transistor is not conducting
2. When IN- is higher than common-mode and IN+ is within common-mode, the output is low and the output transistor is sinking current
3. When IN+ is higher than common-mode and IN- is within common-mode, the output is high impedance and the output transistor is not conducting
4. When IN- and IN+ are both higher than common-mode, see Section 2 of [Application Design Guidelines for LM339, LM393, TL331 Family Comparators Including the New B-versions](#).

8.2.2.2 Minimum Overdrive Voltage

Overdrive Voltage is the differential voltage produced between the positive and negative inputs of the comparator over the offset voltage (V_{IO}). To make an accurate comparison the Overdrive Voltage (V_{OD}) should be higher than the input offset voltage (V_{IO}). Overdrive voltage can also determine the response time of the comparator, with the response time decreasing with increasing overdrive. [Figure 8-2](#) and [Figure 8-3](#) show positive and negative response times with respect to overdrive voltage.

8.2.2.3 Output and Drive Current

Output current is determined by the load/pull-up resistance and logic/pullup voltage. The output current produces a output low voltage (V_{OL}) from the comparator. In which V_{OL} is proportional to the output current. Use [Section 6.14](#) to determine V_{OL} based on the output current.

The output current can also effect the transient response. See [Section 8.2.2.4](#) for more information.

8.2.2.4 Response Time

Response time is a function of input over drive. See [Section 8.2.3](#) for typical response times. The rise and falls times can be determined by the load capacitance (C_L), load/pullup resistance (R_{PULLUP}) and equivalent collector-emitter resistance (R_{CE}).

- The rise time (T_R) is approximately $T_R \sim R_{PULLUP} \times C_L$
- The fall time (T_F) is approximately $T_F \sim R_{CE} \times C_L$
 - R_{CE} can be determine by taking the slope of [Section 6.14](#) in its linear region at the desired temperature, or by dividing the V_{OL} by I_{out}

8.2.3 Application Curves

The following curves were generated with 5 V on V_{CC} and V_{Logic} , $R_{PULLUP} = 5.1\text{ k}\Omega$, and 50 pF scope probe.

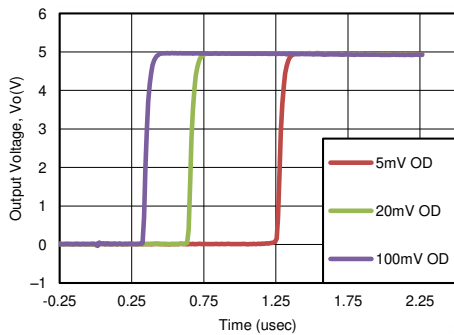

Figure 8-2. Response Time for Various Overdrives (Positive Transition)

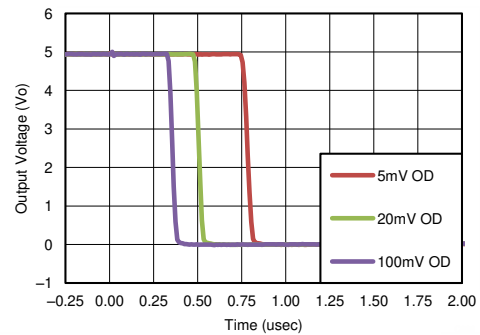

Figure 8-3. Response Time for Various Overdrives (Negative Transition)

8.2.4 Power Supply Recommendations

For fast response and comparison applications with noisy or AC inputs, TI recommends to use a bypass capacitor on the supply pin to reject any variation on the supply voltage. This variation can eat into the input common-mode range of the comparator and create an inaccurate comparison.

8.2.5 Layout

8.2.5.1 Layout Guidelines

For accurate comparator applications without hysteresis it is important maintain a stable power supply with minimized noise and glitches. To achieve this, it is best to add a bypass capacitor between the supply voltage and ground. This should be implemented on the positive power supply and negative supply (if available). If a negative supply is not being used, do not put a capacitor between the IC's GND pin and system ground.

Minimize coupling between outputs and inverting inputs to prevent output oscillations. Do not run output and inverting input traces in parallel unless there is a V_{CC} or GND trace between output and inverting input traces to reduce coupling. When series resistance is added to inputs, place resistor close to the device.

8.2.5.2 Layout Example

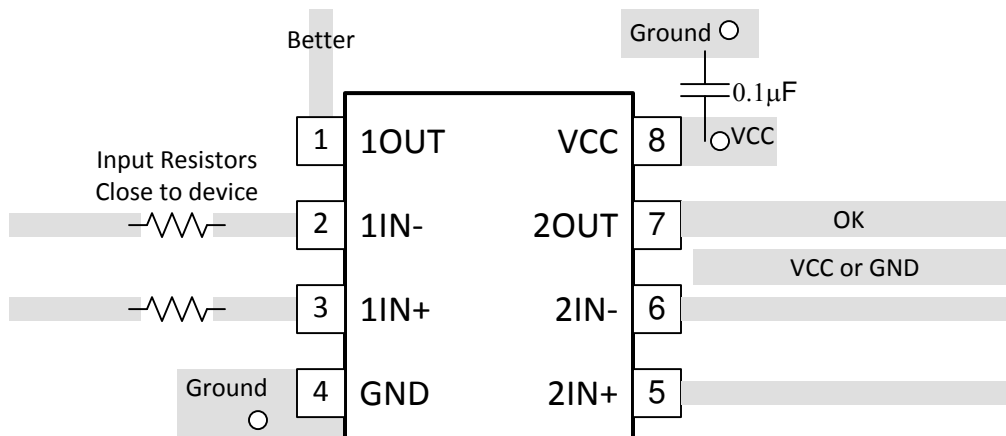

Figure 8-4. LM2903 Layout Example

9 Device and Documentation Support

9.1 Receiving Notification of Documentation Updates

To receive notification of documentation updates, navigate to the device product folder on [ti.com](https://www.ti.com). Click on *Subscribe to updates* to register and receive a weekly digest of any product information that has changed. For change details, review the revision history included in any revised document.

9.2 Support Resources

[TI E2E™ support forums](#) are an engineer's go-to source for fast, verified answers and design help — straight from the experts. Search existing answers or ask your own question to get the quick design help you need.

Linked content is provided "AS IS" by the respective contributors. They do not constitute TI specifications and do not necessarily reflect TI's views; see TI's [Terms of Use](#).

9.3 Trademarks

TI E2E™ is a trademark of Texas Instruments.
All trademarks are the property of their respective owners.

9.4 Electrostatic Discharge Caution



This integrated circuit can be damaged by ESD. Texas Instruments recommends that all integrated circuits be handled with appropriate precautions. Failure to observe proper handling and installation procedures can cause damage.

ESD damage can range from subtle performance degradation to complete device failure. Precision integrated circuits may be more susceptible to damage because very small parametric changes could cause the device not to meet its published specifications.

9.5 Glossary

[TI Glossary](#) This glossary lists and explains terms, acronyms, and definitions.

10 Mechanical, Packaging, and Orderable Information

The following pages include mechanical, packaging, and orderable information. This information is the most current data available for the designated devices. This data is subject to change without notice and revision of this document. For browser based versions of this data sheet, refer to the left hand navigation.

PACKAGING INFORMATION

| Orderable Device | Status (1) | Package Type | Package Drawing | Pins | Package Qty | Eco Plan (2) | Lead finish/ Ball material (6) | MSL Peak Temp (3) | Op Temp (°C) | Device Marking (4/5) | Samples |
|------------------|---------------|--------------|-----------------|------|-------------|-----------------|--------------------------------------|----------------------|--------------|-------------------------|-------------------------|
| LM193DR | ACTIVE | SOIC | D | 8 | 2500 | RoHS & Green | NIPDAU | Level-1-260C-UNLIM | -55 to 125 | LM193 | Samples |
| LM193DRG4 | ACTIVE | SOIC | D | 8 | 2500 | RoHS & Green | NIPDAU | Level-1-260C-UNLIM | -55 to 125 | LM193 | Samples |
| LM2903AVQDR | ACTIVE | SOIC | D | 8 | 2500 | RoHS & Green | NIPDAU | Level-1-260C-UNLIM | -40 to 125 | L2903AV | Samples |
| LM2903AVQDRG4 | ACTIVE | SOIC | D | 8 | 2500 | RoHS & Green | NIPDAU | Level-1-260C-UNLIM | -40 to 125 | L2903AV | Samples |
| LM2903AVQPWR | ACTIVE | TSSOP | PW | 8 | 2000 | RoHS & Green | NIPDAU | Level-1-260C-UNLIM | -40 to 125 | L2903AV | Samples |
| LM2903AVQPWRG4 | ACTIVE | TSSOP | PW | 8 | 2000 | RoHS & Green | NIPDAU | Level-1-260C-UNLIM | -40 to 125 | L2903AV | Samples |
| LM2903BIDDFR | ACTIVE | SOT-23-THIN | DDF | 8 | 3000 | RoHS & Green | NIPDAU | Level-1-260C-UNLIM | -40 to 125 | 2903B | Samples |
| LM2903BIDGKR | ACTIVE | VSSOP | DGK | 8 | 2500 | RoHS & Green | NIPDAU | Level-1-260C-UNLIM | -40 to 125 | 903B | Samples |
| LM2903BIDR | ACTIVE | SOIC | D | 8 | 2500 | RoHS & Green | NIPDAU | Level-1-260C-UNLIM | -40 to 125 | L2903B | Samples |
| LM2903BIDSGR | ACTIVE | WSON | DSG | 8 | 3000 | RoHS & Green | NIPDAU | Level-1-260C-UNLIM | -40 to 125 | 903B | Samples |
| LM2903BIPWR | ACTIVE | TSSOP | PW | 8 | 2000 | RoHS & Green | NIPDAU | Level-1-260C-UNLIM | -40 to 125 | L2903B | Samples |
| LM2903D | NRND | SOIC | D | 8 | 75 | RoHS & Green | NIPDAU | Level-1-260C-UNLIM | -40 to 125 | LM2903 | |
| LM2903DE4 | NRND | SOIC | D | 8 | 75 | RoHS & Green | NIPDAU | Level-1-260C-UNLIM | -40 to 125 | LM2903 | |
| LM2903DG4 | NRND | SOIC | D | 8 | 75 | RoHS & Green | NIPDAU | Level-1-260C-UNLIM | -40 to 125 | LM2903 | |
| LM2903DGKR | ACTIVE | VSSOP | DGK | 8 | 2500 | RoHS & Green | NIPDAUAG SN | Level-1-260C-UNLIM | -40 to 125 | (MAP, MAS, MAU) | Samples |
| LM2903DR | ACTIVE | SOIC | D | 8 | 2500 | RoHS & Green | NIPDAU SN | Level-1-260C-UNLIM | -40 to 125 | LM2903 | Samples |
| LM2903DRE4 | LIFEBUY | SOIC | D | 8 | 2500 | RoHS & Green | NIPDAU | Level-1-260C-UNLIM | -40 to 125 | LM2903 | |
| LM2903DRG3 | ACTIVE | SOIC | D | 8 | 2500 | RoHS & Green | SN | Level-1-260C-UNLIM | -40 to 125 | LM2903 | Samples |
| LM2903DRG4 | LIFEBUY | SOIC | D | 8 | 2500 | RoHS & Green | NIPDAU | Level-1-260C-UNLIM | -40 to 125 | LM2903 | |
| LM2903P | ACTIVE | PDIP | P | 8 | 50 | RoHS & Green | NIPDAU | N / A for Pkg Type | -40 to 125 | LM2903P | Samples |
| LM2903PSR | ACTIVE | SO | PS | 8 | 2000 | RoHS & Green | NIPDAU | Level-1-260C-UNLIM | -40 to 125 | L2903 | Samples |

| Orderable Device | Status (1) | Package Type | Package Drawing | Pins | Package Qty | Eco Plan (2) | Lead finish/ Ball material (6) | MSL Peak Temp (3) | Op Temp (°C) | Device Marking (4/5) | Samples |
|------------------|---------------|--------------|-----------------|------|-------------|-----------------|--------------------------------------|----------------------|--------------|-------------------------|-------------------------|
| LM2903PWR | ACTIVE | TSSOP | PW | 8 | 2000 | RoHS & Green | NIPDAU SN | Level-1-260C-UNLIM | -40 to 125 | L2903 | Samples |
| LM2903PWRG3 | ACTIVE | TSSOP | PW | 8 | 2000 | RoHS & Green | SN | Level-1-260C-UNLIM | -40 to 125 | L2903 | Samples |
| LM2903PWRG4 | ACTIVE | TSSOP | PW | 8 | 2000 | RoHS & Green | NIPDAU | Level-1-260C-UNLIM | -40 to 125 | L2903 | Samples |
| LM2903QD | ACTIVE | SOIC | D | 8 | 75 | RoHS & Green | NIPDAU | Level-1-260C-UNLIM | -40 to 125 | 2903Q | Samples |
| LM2903QDG4 | NRND | SOIC | D | 8 | 75 | RoHS & Green | NIPDAU | Level-1-260C-UNLIM | -40 to 125 | 2903Q | |
| LM2903QDRG4 | ACTIVE | SOIC | D | 8 | 2500 | RoHS & Green | NIPDAU | Level-1-260C-UNLIM | -40 to 125 | 2903Q | Samples |
| LM2903VQDR | ACTIVE | SOIC | D | 8 | 2500 | RoHS & Green | NIPDAU | Level-1-260C-UNLIM | -40 to 125 | L2903V | Samples |
| LM2903VQDRG4 | ACTIVE | SOIC | D | 8 | 2500 | RoHS & Green | NIPDAU | Level-1-260C-UNLIM | -40 to 125 | L2903V | Samples |
| LM2903VQPWR | ACTIVE | TSSOP | PW | 8 | 2000 | RoHS & Green | NIPDAU | Level-1-260C-UNLIM | -40 to 125 | L2903V | Samples |
| LM2903VQPWRG4 | ACTIVE | TSSOP | PW | 8 | 2000 | RoHS & Green | NIPDAU | Level-1-260C-UNLIM | -40 to 125 | L2903V | Samples |
| LM293AD | NRND | SOIC | D | 8 | 75 | RoHS & Green | NIPDAU | Level-1-260C-UNLIM | -25 to 85 | LM293A | |
| LM293ADE4 | NRND | SOIC | D | 8 | 75 | RoHS & Green | NIPDAU | Level-1-260C-UNLIM | -25 to 85 | LM293A | |
| LM293ADGKR | ACTIVE | VSSOP | DGK | 8 | 2500 | RoHS & Green | NIPDAU SN NIPDAUAG | Level-1-260C-UNLIM | -25 to 85 | (MDP, MDS, MDU) | Samples |
| LM293ADGKRG4 | ACTIVE | VSSOP | DGK | 8 | 2500 | TBD | Call TI | Call TI | -25 to 85 | | Samples |
| LM293ADR | ACTIVE | SOIC | D | 8 | 2500 | RoHS & Green | NIPDAU SN | Level-1-260C-UNLIM | -25 to 85 | LM293A | Samples |
| LM293ADRG4 | ACTIVE | SOIC | D | 8 | 2500 | RoHS & Green | NIPDAU | Level-1-260C-UNLIM | -25 to 85 | LM293A | Samples |
| LM293D | NRND | SOIC | D | 8 | 75 | RoHS & Green | NIPDAU | Level-1-260C-UNLIM | -25 to 85 | LM293 | |
| LM293DGKR | ACTIVE | VSSOP | DGK | 8 | 2500 | RoHS & Green | NIPDAU SN NIPDAUAG | Level-1-260C-UNLIM | -25 to 85 | (MCP, MCS, MCU) | Samples |
| LM293DGKRG4 | ACTIVE | VSSOP | DGK | 8 | 2500 | TBD | Call TI | Call TI | -25 to 85 | | Samples |
| LM293DR | ACTIVE | SOIC | D | 8 | 2500 | RoHS & Green | NIPDAU SN | Level-1-260C-UNLIM | -25 to 85 | LM293 | Samples |
| LM293DRE4 | LIFEBUY | SOIC | D | 8 | 2500 | RoHS & Green | NIPDAU | Level-1-260C-UNLIM | -25 to 85 | LM293 | |
| LM293DRG3 | ACTIVE | SOIC | D | 8 | 2500 | RoHS & Green | SN | Level-1-260C-UNLIM | -25 to 85 | LM293 | Samples |

| Orderable Device | Status (1) | Package Type | Package Drawing | Pins | Package Qty | Eco Plan (2) | Lead finish/ Ball material (6) | MSL Peak Temp (3) | Op Temp (°C) | Device Marking (4/5) | Samples |
|------------------|---------------|--------------|-----------------|------|-------------|-----------------|--------------------------------------|----------------------|--------------|-------------------------|---------|
| LM293DRG4 | LIFEBUY | SOIC | D | 8 | 2500 | RoHS & Green | NIPDAU | Level-1-260C-UNLIM | -25 to 85 | LM293 | |
| LM293P | ACTIVE | PDIP | P | 8 | 50 | RoHS & Green | NIPDAU SN | N / A for Pkg Type | -25 to 85 | LM293P | Samples |
| LM293PE4 | LIFEBUY | PDIP | P | 8 | 50 | RoHS & Green | NIPDAU | N / A for Pkg Type | -25 to 85 | LM293P | |
| LM393AD | NRND | SOIC | D | 8 | 75 | RoHS & Green | NIPDAU | Level-1-260C-UNLIM | 0 to 70 | LM393A | |
| LM393ADE4 | NRND | SOIC | D | 8 | 75 | RoHS & Green | NIPDAU | Level-1-260C-UNLIM | 0 to 70 | LM393A | |
| LM393ADG4 | NRND | SOIC | D | 8 | 75 | RoHS & Green | NIPDAU | Level-1-260C-UNLIM | 0 to 70 | LM393A | |
| LM393ADGKR | ACTIVE | VSSOP | DGK | 8 | 2500 | RoHS & Green | NIPDAU NIPDAUAG | Level-1-260C-UNLIM | 0 to 70 | (M8P, M8S, M8U) | Samples |
| LM393ADGKRG4 | ACTIVE | VSSOP | DGK | 8 | 2500 | TBD | Call TI | Call TI | 0 to 70 | | Samples |
| LM393ADR | ACTIVE | SOIC | D | 8 | 2500 | RoHS & Green | NIPDAU SN | Level-1-260C-UNLIM | 0 to 70 | LM393A | Samples |
| LM393ADRE4 | LIFEBUY | SOIC | D | 8 | 2500 | RoHS & Green | NIPDAU | Level-1-260C-UNLIM | 0 to 70 | LM393A | |
| LM393ADRG4 | LIFEBUY | SOIC | D | 8 | 2500 | RoHS & Green | NIPDAU | Level-1-260C-UNLIM | 0 to 70 | LM393A | |
| LM393AP | ACTIVE | PDIP | P | 8 | 50 | RoHS & Green | NIPDAU SN | N / A for Pkg Type | 0 to 70 | LM393AP | Samples |
| LM393APE4 | LIFEBUY | PDIP | P | 8 | 50 | RoHS & Green | NIPDAU | N / A for Pkg Type | 0 to 70 | LM393AP | |
| LM393APSR | LIFEBUY | SO | PS | 8 | 2000 | RoHS & Green | NIPDAU | Level-1-260C-UNLIM | 0 to 70 | L393A | |
| LM393APWR | ACTIVE | TSSOP | PW | 8 | 2000 | RoHS & Green | NIPDAU SN | Level-1-260C-UNLIM | 0 to 70 | L393A | Samples |
| LM393APWRE4 | LIFEBUY | TSSOP | PW | 8 | 2000 | RoHS & Green | NIPDAU | Level-1-260C-UNLIM | 0 to 70 | L393A | |
| LM393APWRG4 | LIFEBUY | TSSOP | PW | 8 | 2000 | RoHS & Green | NIPDAU | Level-1-260C-UNLIM | 0 to 70 | L393A | |
| LM393BIDDFR | ACTIVE | SOT-23-THIN | DDF | 8 | 3000 | RoHS & Green | NIPDAU | Level-1-260C-UNLIM | -40 to 85 | 393B | Samples |
| LM393BIDGKR | ACTIVE | VSSOP | DGK | 8 | 2500 | RoHS & Green | NIPDAU | Level-1-260C-UNLIM | -40 to 85 | 393B | Samples |
| LM393BIDR | ACTIVE | SOIC | D | 8 | 2500 | RoHS & Green | NIPDAU | Level-1-260C-UNLIM | -40 to 85 | LM393B | Samples |
| LM393BIDSGR | ACTIVE | WSON | DSG | 8 | 3000 | RoHS & Green | NIPDAU | Level-1-260C-UNLIM | -40 to 85 | 393B | Samples |
| LM393BIPWR | ACTIVE | TSSOP | PW | 8 | 2000 | RoHS & Green | NIPDAU | Level-1-260C-UNLIM | -40 to 85 | LM393B | Samples |
| LM393D | NRND | SOIC | D | 8 | 75 | RoHS & Green | NIPDAU | Level-1-260C-UNLIM | 0 to 70 | LM393 | |
| LM393DE4 | NRND | SOIC | D | 8 | 75 | RoHS & Green | NIPDAU | Level-1-260C-UNLIM | 0 to 70 | LM393 | |
| LM393DG4 | NRND | SOIC | D | 8 | 75 | RoHS & Green | NIPDAU | Level-1-260C-UNLIM | 0 to 70 | LM393 | |

| Orderable Device | Status (1) | Package Type | Package Drawing | Pins | Package Qty | Eco Plan (2) | Lead finish/ Ball material (6) | MSL Peak Temp (3) | Op Temp (°C) | Device Marking (4/5) | Samples |
|------------------|---------------|--------------|-----------------|------|-------------|---------------------|--------------------------------------|----------------------|--------------|-------------------------|-------------------------|
| LM393DGKR | ACTIVE | VSSOP | DGK | 8 | 2500 | RoHS & Green | NIPDAU SN NIPDAUAG | Level-1-260C-UNLIM | 0 to 70 | (M9P, M9S, M9U) | Samples |
| LM393DGKRG4 | ACTIVE | VSSOP | DGK | 8 | 2500 | TBD | Call TI | Call TI | 0 to 70 | | Samples |
| LM393DR | ACTIVE | SOIC | D | 8 | 2500 | RoHS & Green | NIPDAU SN | Level-1-260C-UNLIM | 0 to 70 | LM393 | Samples |
| LM393DRE4 | LIFEBUY | SOIC | D | 8 | 2500 | RoHS & Green | NIPDAU | Level-1-260C-UNLIM | 0 to 70 | LM393 | |
| LM393DRG3 | ACTIVE | SOIC | D | 8 | 2500 | RoHS & Green | SN | Level-1-260C-UNLIM | 0 to 70 | LM393 | Samples |
| LM393DRG4 | LIFEBUY | SOIC | D | 8 | 2500 | RoHS & Green | NIPDAU | Level-1-260C-UNLIM | 0 to 70 | LM393 | |
| LM393P | ACTIVE | PDIP | P | 8 | 50 | RoHS & Green | NIPDAU SN | N / A for Pkg Type | 0 to 70 | LM393P | Samples |
| LM393PE3 | ACTIVE | PDIP | P | 8 | 50 | RoHS & Non-Green | SN | N / A for Pkg Type | 0 to 70 | LM393P | Samples |
| LM393PE4 | ACTIVE | PDIP | P | 8 | 50 | RoHS & Green | NIPDAU | N / A for Pkg Type | 0 to 70 | LM393P | Samples |
| LM393PSR | LIFEBUY | SO | PS | 8 | 2000 | RoHS & Green | NIPDAU | Level-1-260C-UNLIM | 0 to 70 | L393 | |
| LM393PSRG4 | LIFEBUY | SO | PS | 8 | 2000 | RoHS & Green | NIPDAU | Level-1-260C-UNLIM | 0 to 70 | L393 | |
| LM393PW | NRND | TSSOP | PW | 8 | 150 | RoHS & Green | NIPDAU | Level-1-260C-UNLIM | 0 to 70 | L393 | |
| LM393PWG4 | NRND | TSSOP | PW | 8 | 150 | RoHS & Green | NIPDAU | Level-1-260C-UNLIM | 0 to 70 | L393 | |
| LM393PWR | ACTIVE | TSSOP | PW | 8 | 2000 | RoHS & Green | NIPDAU SN | Level-1-260C-UNLIM | 0 to 70 | L393 | Samples |
| LM393PWRG3 | ACTIVE | TSSOP | PW | 8 | 2000 | RoHS & Green | SN | Level-1-260C-UNLIM | 0 to 70 | L393 | Samples |
| LM393PWRG4 | ACTIVE | TSSOP | PW | 8 | 2000 | RoHS & Green | NIPDAU | Level-1-260C-UNLIM | 0 to 70 | L393 | Samples |

(1) The marketing status values are defined as follows:

ACTIVE: Product device recommended for new designs.

LIFEBUY: TI has announced that the device will be discontinued, and a lifetime-buy period is in effect.

NRND: Not recommended for new designs. Device is in production to support existing customers, but TI does not recommend using this part in a new design.

PREVIEW: Device has been announced but is not in production. Samples may or may not be available.

OBSELETE: TI has discontinued the production of the device.

(2) **RoHS:** TI defines "RoHS" to mean semiconductor products that are compliant with the current EU RoHS requirements for all 10 RoHS substances, including the requirement that RoHS substance do not exceed 0.1% by weight in homogeneous materials. Where designed to be soldered at high temperatures, "RoHS" products are suitable for use in specified lead-free processes. TI may reference these types of products as "Pb-Free".

RoHS Exempt: TI defines "RoHS Exempt" to mean products that contain lead but are compliant with EU RoHS pursuant to a specific EU RoHS exemption.

Green: TI defines "Green" to mean the content of Chlorine (Cl) and Bromine (Br) based flame retardants meet JS709B low halogen requirements of ≤ 1000 ppm threshold. Antimony trioxide based flame retardants must also meet the ≤ 1000 ppm threshold requirement.

- (3) MSL, Peak Temp. - The Moisture Sensitivity Level rating according to the JEDEC industry standard classifications, and peak solder temperature.
- (4) There may be additional marking, which relates to the logo, the lot trace code information, or the environmental category on the device.
- (5) Multiple Device Markings will be inside parentheses. Only one Device Marking contained in parentheses and separated by a "~" will appear on a device. If a line is indented then it is a continuation of the previous line and the two combined represent the entire Device Marking for that device.
- (6) Lead finish/Ball material - Orderable Devices may have multiple material finish options. Finish options are separated by a vertical ruled line. Lead finish/Ball material values may wrap to two lines if the finish value exceeds the maximum column width.

Important Information and Disclaimer: The information provided on this page represents TI's knowledge and belief as of the date that it is provided. TI bases its knowledge and belief on information provided by third parties, and makes no representation or warranty as to the accuracy of such information. Efforts are underway to better integrate information from third parties. TI has taken and continues to take reasonable steps to provide representative and accurate information but may not have conducted destructive testing or chemical analysis on incoming materials and chemicals. TI and TI suppliers consider certain information to be proprietary, and thus CAS numbers and other limited information may not be available for release.

In no event shall TI's liability arising out of such information exceed the total purchase price of the TI part(s) at issue in this document sold by TI to Customer on an annual basis.

OTHER QUALIFIED VERSIONS OF LM2903, LM2903B, LM293 :

- Automotive : [LM2903-Q1](#), [LM2903B-Q1](#)
- Enhanced Product : [LM293-EP](#)

NOTE: Qualified Version Definitions:

- Automotive - Q100 devices qualified for high-reliability automotive applications targeting zero defects
- Enhanced Product - Supports Defense, Aerospace and Medical Applications

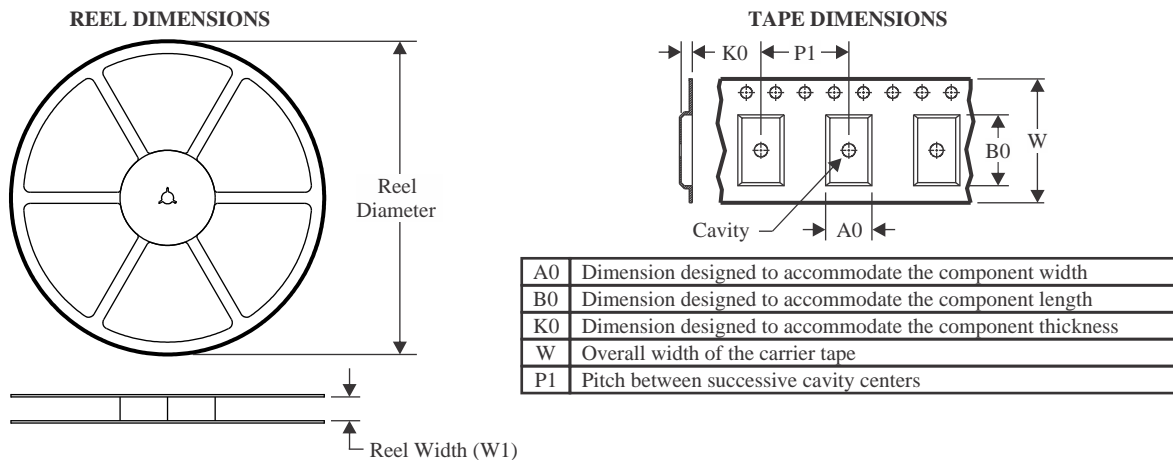
TAPE AND REEL INFORMATION

QUADRANT ASSIGNMENTS FOR PIN 1 ORIENTATION IN TAPE

*All dimensions are nominal

| Device | Package Type | Package Drawing | Pins | SPQ | Reel Diameter (mm) | Reel Width W1 (mm) | A0 (mm) | B0 (mm) | K0 (mm) | P1 (mm) | W (mm) | Pin1 Quadrant |
|----------------|--------------|-----------------|------|------|--------------------|--------------------|---------|---------|---------|---------|--------|---------------|
| LM193DR | SOIC | D | 8 | 2500 | 330.0 | 12.4 | 6.4 | 5.2 | 2.1 | 8.0 | 12.0 | Q1 |
| LM2903AVQDR | SOIC | D | 8 | 2500 | 330.0 | 12.4 | 6.4 | 5.2 | 2.1 | 8.0 | 12.0 | Q1 |
| LM2903AVQDR | SOIC | D | 8 | 2500 | 330.0 | 12.5 | 6.4 | 5.2 | 2.1 | 8.0 | 12.0 | Q1 |
| LM2903AVQDRG4 | SOIC | D | 8 | 2500 | 330.0 | 12.4 | 6.4 | 5.2 | 2.1 | 8.0 | 12.0 | Q1 |
| LM2903AVQPWR | TSSOP | PW | 8 | 2000 | 330.0 | 12.4 | 7.0 | 3.6 | 1.6 | 8.0 | 12.0 | Q1 |
| LM2903AVQPWRG4 | TSSOP | PW | 8 | 2000 | 330.0 | 12.4 | 7.0 | 3.6 | 1.6 | 8.0 | 12.0 | Q1 |
| LM2903BIDDFR | SOT-23-THIN | DDF | 8 | 3000 | 180.0 | 8.4 | 3.2 | 3.2 | 1.4 | 4.0 | 8.0 | Q3 |
| LM2903BIDGKR | VSSOP | DGK | 8 | 2500 | 330.0 | 12.4 | 5.3 | 3.4 | 1.4 | 8.0 | 12.0 | Q1 |
| LM2903BIDR | SOIC | D | 8 | 2500 | 330.0 | 12.4 | 6.4 | 5.2 | 2.1 | 8.0 | 12.0 | Q1 |
| LM2903BIDSGR | WSO | DSG | 8 | 3000 | 180.0 | 8.4 | 2.3 | 2.3 | 1.15 | 4.0 | 8.0 | Q2 |
| LM2903BIPWR | TSSOP | PW | 8 | 2000 | 330.0 | 12.4 | 7.0 | 3.6 | 1.6 | 8.0 | 12.0 | Q1 |
| LM2903DGKR | VSSOP | DGK | 8 | 2500 | 330.0 | 12.4 | 5.3 | 3.4 | 1.4 | 8.0 | 12.0 | Q1 |
| LM2903DGKR | VSSOP | DGK | 8 | 2500 | 330.0 | 12.4 | 5.3 | 3.4 | 1.4 | 8.0 | 12.0 | Q1 |
| LM2903DR | SOIC | D | 8 | 2500 | 330.0 | 12.4 | 6.4 | 5.2 | 2.1 | 8.0 | 12.0 | Q1 |
| LM2903DR | SOIC | D | 8 | 2500 | 330.0 | 12.8 | 6.4 | 5.2 | 2.1 | 8.0 | 12.0 | Q1 |

| Device | Package Type | Package Drawing | Pins | SPQ | Reel Diameter (mm) | Reel Width W1 (mm) | A0 (mm) | B0 (mm) | K0 (mm) | P1 (mm) | W (mm) | Pin1 Quadrant |
|---------------|--------------|-----------------|------|------|--------------------|--------------------|---------|---------|---------|---------|--------|---------------|
| LM2903DR | SOIC | D | 8 | 2500 | 330.0 | 12.4 | 6.4 | 5.2 | 2.1 | 8.0 | 12.0 | Q1 |
| LM2903DRG3 | SOIC | D | 8 | 2500 | 330.0 | 12.8 | 6.4 | 5.2 | 2.1 | 8.0 | 12.0 | Q1 |
| LM2903DRG4 | SOIC | D | 8 | 2500 | 330.0 | 12.4 | 6.4 | 5.2 | 2.1 | 8.0 | 12.0 | Q1 |
| LM2903DRG4 | SOIC | D | 8 | 2500 | 330.0 | 12.4 | 6.4 | 5.2 | 2.1 | 8.0 | 12.0 | Q1 |
| LM2903PSR | SO | PS | 8 | 2000 | 330.0 | 16.4 | 8.35 | 6.6 | 2.4 | 12.0 | 16.0 | Q1 |
| LM2903PWR | TSSOP | PW | 8 | 2000 | 330.0 | 12.4 | 7.0 | 3.6 | 1.6 | 8.0 | 12.0 | Q1 |
| LM2903PWR | TSSOP | PW | 8 | 2000 | 330.0 | 12.4 | 7.0 | 3.6 | 1.6 | 8.0 | 12.0 | Q1 |
| LM2903PWR | TSSOP | PW | 8 | 2000 | 330.0 | 12.4 | 7.0 | 3.6 | 1.6 | 8.0 | 12.0 | Q1 |
| LM2903PWRG3 | TSSOP | PW | 8 | 2000 | 330.0 | 12.4 | 7.0 | 3.6 | 1.6 | 8.0 | 12.0 | Q1 |
| LM2903PWRG4 | TSSOP | PW | 8 | 2000 | 330.0 | 12.4 | 7.0 | 3.6 | 1.6 | 8.0 | 12.0 | Q1 |
| LM2903QDRG4 | SOIC | D | 8 | 2500 | 330.0 | 12.4 | 6.4 | 5.2 | 2.1 | 8.0 | 12.0 | Q1 |
| LM2903VQDR | SOIC | D | 8 | 2500 | 330.0 | 12.4 | 6.4 | 5.2 | 2.1 | 8.0 | 12.0 | Q1 |
| LM2903VQDR | SOIC | D | 8 | 2500 | 330.0 | 12.5 | 6.4 | 5.2 | 2.1 | 8.0 | 12.0 | Q1 |
| LM2903VQDRG4 | SOIC | D | 8 | 2500 | 330.0 | 12.4 | 6.4 | 5.2 | 2.1 | 8.0 | 12.0 | Q1 |
| LM2903VQPWR | TSSOP | PW | 8 | 2000 | 330.0 | 12.4 | 7.0 | 3.6 | 1.6 | 8.0 | 12.0 | Q1 |
| LM2903VQPWR | TSSOP | PW | 8 | 2000 | 330.0 | 12.4 | 7.0 | 3.6 | 1.6 | 8.0 | 12.0 | Q1 |
| LM2903VQPWRG4 | TSSOP | PW | 8 | 2000 | 330.0 | 12.4 | 7.0 | 3.6 | 1.6 | 8.0 | 12.0 | Q1 |
| LM293ADGKR | VSSOP | DGK | 8 | 2500 | 330.0 | 12.4 | 5.3 | 3.4 | 1.4 | 8.0 | 12.0 | Q1 |
| LM293ADGKR | VSSOP | DGK | 8 | 2500 | 330.0 | 12.4 | 5.3 | 3.4 | 1.4 | 8.0 | 12.0 | Q1 |
| LM293ADGKR | VSSOP | DGK | 8 | 2500 | 330.0 | 12.4 | 5.3 | 3.3 | 1.3 | 8.0 | 12.0 | Q1 |
| LM293ADGKR | VSSOP | DGK | 8 | 2500 | 330.0 | 12.4 | 5.3 | 3.4 | 1.4 | 8.0 | 12.0 | Q1 |
| LM293ADR | SOIC | D | 8 | 2500 | 330.0 | 12.4 | 6.4 | 5.2 | 2.1 | 8.0 | 12.0 | Q1 |
| LM293ADR | SOIC | D | 8 | 2500 | 330.0 | 12.8 | 6.4 | 5.2 | 2.1 | 8.0 | 12.0 | Q1 |
| LM293ADR | SOIC | D | 8 | 2500 | 330.0 | 12.4 | 6.4 | 5.2 | 2.1 | 8.0 | 12.0 | Q1 |
| LM293ADRG4 | SOIC | D | 8 | 2500 | 330.0 | 12.4 | 6.4 | 5.2 | 2.1 | 8.0 | 12.0 | Q1 |
| LM293ADRG4 | SOIC | D | 8 | 2500 | 330.0 | 12.4 | 6.4 | 5.2 | 2.1 | 8.0 | 12.0 | Q1 |
| LM293ADRG4 | SOIC | D | 8 | 2500 | 330.0 | 12.4 | 6.4 | 5.2 | 2.1 | 8.0 | 12.0 | Q1 |
| LM293ADRG4 | SOIC | D | 8 | 2500 | 330.0 | 12.4 | 6.4 | 5.2 | 2.1 | 8.0 | 12.0 | Q1 |
| LM293ADRG4 | SOIC | D | 8 | 2500 | 330.0 | 12.4 | 6.4 | 5.2 | 2.1 | 8.0 | 12.0 | Q1 |
| LM293ADRG4 | SOIC | D | 8 | 2500 | 330.0 | 12.4 | 6.4 | 5.2 | 2.1 | 8.0 | 12.0 | Q1 |
| LM293DGKR | VSSOP | DGK | 8 | 2500 | 330.0 | 12.4 | 5.3 | 3.4 | 1.4 | 8.0 | 12.0 | Q1 |
| LM293DGKR | VSSOP | DGK | 8 | 2500 | 330.0 | 12.4 | 5.3 | 3.4 | 1.4 | 8.0 | 12.0 | Q1 |
| LM293DR | SOIC | D | 8 | 2500 | 330.0 | 12.8 | 6.4 | 5.2 | 2.1 | 8.0 | 12.0 | Q1 |
| LM293DR | SOIC | D | 8 | 2500 | 330.0 | 12.4 | 6.4 | 5.2 | 2.1 | 8.0 | 12.0 | Q1 |
| LM293DR | SOIC | D | 8 | 2500 | 330.0 | 12.4 | 6.4 | 5.2 | 2.1 | 8.0 | 12.0 | Q1 |
| LM293DRG3 | SOIC | D | 8 | 2500 | 330.0 | 12.8 | 6.4 | 5.2 | 2.1 | 8.0 | 12.0 | Q1 |
| LM293DRG4 | SOIC | D | 8 | 2500 | 330.0 | 12.4 | 6.4 | 5.2 | 2.1 | 8.0 | 12.0 | Q1 |
| LM293DRG4 | SOIC | D | 8 | 2500 | 330.0 | 12.4 | 6.4 | 5.2 | 2.1 | 8.0 | 12.0 | Q1 |
| LM393ADGKR | VSSOP | DGK | 8 | 2500 | 330.0 | 12.4 | 5.3 | 3.4 | 1.4 | 8.0 | 12.0 | Q1 |
| LM393ADGKR | VSSOP | DGK | 8 | 2500 | 330.0 | 12.4 | 5.3 | 3.4 | 1.4 | 8.0 | 12.0 | Q1 |
| LM393ADGKR | VSSOP | DGK | 8 | 2500 | 330.0 | 12.4 | 5.3 | 3.3 | 1.3 | 8.0 | 12.0 | Q1 |
| LM393ADR | SOIC | D | 8 | 2500 | 330.0 | 12.4 | 6.4 | 5.2 | 2.1 | 8.0 | 12.0 | Q1 |
| LM393ADR | SOIC | D | 8 | 2500 | 330.0 | 12.8 | 6.4 | 5.2 | 2.1 | 8.0 | 12.0 | Q1 |

| Device | Package Type | Package Drawing | Pins | SPQ | Reel Diameter (mm) | Reel Width W1 (mm) | A0 (mm) | B0 (mm) | K0 (mm) | P1 (mm) | W (mm) | Pin1 Quadrant |
|-------------|--------------|-----------------|------|------|--------------------|--------------------|---------|---------|---------|---------|--------|---------------|
| LM393ADR | SOIC | D | 8 | 2500 | 330.0 | 12.4 | 6.4 | 5.2 | 2.1 | 8.0 | 12.0 | Q1 |
| LM393ADRG4 | SOIC | D | 8 | 2500 | 330.0 | 12.4 | 6.4 | 5.2 | 2.1 | 8.0 | 12.0 | Q1 |
| LM393ADRG4 | SOIC | D | 8 | 2500 | 330.0 | 12.4 | 6.4 | 5.2 | 2.1 | 8.0 | 12.0 | Q1 |
| LM393APSR | SO | PS | 8 | 2000 | 330.0 | 16.4 | 8.35 | 6.6 | 2.4 | 12.0 | 16.0 | Q1 |
| LM393APWR | TSSOP | PW | 8 | 2000 | 330.0 | 12.4 | 7.0 | 3.6 | 1.6 | 8.0 | 12.0 | Q1 |
| LM393APWR | TSSOP | PW | 8 | 2000 | 330.0 | 12.4 | 7.0 | 3.6 | 1.6 | 8.0 | 12.0 | Q1 |
| LM393APWR | TSSOP | PW | 8 | 2000 | 330.0 | 12.4 | 7.0 | 3.6 | 1.6 | 8.0 | 12.0 | Q1 |
| LM393APWRG4 | TSSOP | PW | 8 | 2000 | 330.0 | 12.4 | 7.0 | 3.6 | 1.6 | 8.0 | 12.0 | Q1 |
| LM393BIDDFR | SOT-23-THIN | DDF | 8 | 3000 | 180.0 | 8.4 | 3.2 | 3.2 | 1.4 | 4.0 | 8.0 | Q3 |
| LM393BIDGKR | VSSOP | DGK | 8 | 2500 | 330.0 | 12.4 | 5.3 | 3.4 | 1.4 | 8.0 | 12.0 | Q1 |
| LM393BIDR | SOIC | D | 8 | 2500 | 330.0 | 12.4 | 6.4 | 5.2 | 2.1 | 8.0 | 12.0 | Q1 |
| LM393BIDSGR | WSON | DSG | 8 | 3000 | 180.0 | 8.4 | 2.3 | 2.3 | 1.15 | 4.0 | 8.0 | Q2 |
| LM393BIPWR | TSSOP | PW | 8 | 2000 | 330.0 | 12.4 | 7.0 | 3.6 | 1.6 | 8.0 | 12.0 | Q1 |
| LM393DGKR | VSSOP | DGK | 8 | 2500 | 330.0 | 12.4 | 5.3 | 3.4 | 1.4 | 8.0 | 12.0 | Q1 |
| LM393DGKR | VSSOP | DGK | 8 | 2500 | 330.0 | 12.4 | 5.3 | 3.4 | 1.4 | 8.0 | 12.0 | Q1 |
| LM393DR | SOIC | D | 8 | 2500 | 330.0 | 12.4 | 6.4 | 5.2 | 2.1 | 8.0 | 12.0 | Q1 |
| LM393DR | SOIC | D | 8 | 2500 | 330.0 | 12.4 | 6.4 | 5.2 | 2.1 | 8.0 | 12.0 | Q1 |
| LM393DRG3 | SOIC | D | 8 | 2500 | 330.0 | 15.4 | 6.4 | 5.2 | 2.1 | 8.0 | 12.0 | Q1 |
| LM393DRG3 | SOIC | D | 8 | 2500 | 330.0 | 12.8 | 6.4 | 5.2 | 2.1 | 8.0 | 12.0 | Q1 |
| LM393DRG4 | SOIC | D | 8 | 2500 | 330.0 | 12.4 | 6.4 | 5.2 | 2.1 | 8.0 | 12.0 | Q1 |
| LM393DRG4 | SOIC | D | 8 | 2500 | 330.0 | 12.4 | 6.4 | 5.2 | 2.1 | 8.0 | 12.0 | Q1 |
| LM393PSR | SO | PS | 8 | 2000 | 330.0 | 16.4 | 8.35 | 6.6 | 2.4 | 12.0 | 16.0 | Q1 |
| LM393PWR | TSSOP | PW | 8 | 2000 | 330.0 | 12.4 | 7.0 | 3.6 | 1.6 | 8.0 | 12.0 | Q1 |
| LM393PWR | TSSOP | PW | 8 | 2000 | 330.0 | 12.4 | 7.0 | 3.6 | 1.6 | 8.0 | 12.0 | Q1 |
| LM393PWRG3 | TSSOP | PW | 8 | 2000 | 330.0 | 12.4 | 7.0 | 3.6 | 1.6 | 8.0 | 12.0 | Q1 |
| LM393PWRG4 | TSSOP | PW | 8 | 2000 | 330.0 | 12.4 | 7.0 | 3.6 | 1.6 | 8.0 | 12.0 | Q1 |

TAPE AND REEL BOX DIMENSIONS

*All dimensions are nominal

| Device | Package Type | Package Drawing | Pins | SPQ | Length (mm) | Width (mm) | Height (mm) |
|----------------|--------------|-----------------|------|------|-------------|------------|-------------|
| LM193DR | SOIC | D | 8 | 2500 | 350.0 | 350.0 | 43.0 |
| LM2903AVQDR | SOIC | D | 8 | 2500 | 340.5 | 338.1 | 20.6 |
| LM2903AVQDR | SOIC | D | 8 | 2500 | 340.5 | 336.1 | 25.0 |
| LM2903AVQDRG4 | SOIC | D | 8 | 2500 | 340.5 | 338.1 | 20.6 |
| LM2903AVQPWR | TSSOP | PW | 8 | 2000 | 356.0 | 356.0 | 35.0 |
| LM2903AVQPWRG4 | TSSOP | PW | 8 | 2000 | 356.0 | 356.0 | 35.0 |
| LM2903BIDDFR | SOT-23-THIN | DDF | 8 | 3000 | 210.0 | 185.0 | 35.0 |
| LM2903BIDGKR | VSSOP | DGK | 8 | 2500 | 366.0 | 364.0 | 50.0 |
| LM2903BIDR | SOIC | D | 8 | 2500 | 340.5 | 336.1 | 25.0 |
| LM2903BIDSGR | WSON | DSG | 8 | 3000 | 210.0 | 185.0 | 35.0 |
| LM2903BIPWR | TSSOP | PW | 8 | 2000 | 356.0 | 356.0 | 35.0 |
| LM2903DGKR | VSSOP | DGK | 8 | 2500 | 366.0 | 364.0 | 50.0 |
| LM2903DGKR | VSSOP | DGK | 8 | 2500 | 364.0 | 364.0 | 27.0 |
| LM2903DR | SOIC | D | 8 | 2500 | 340.5 | 338.1 | 20.6 |
| LM2903DR | SOIC | D | 8 | 2500 | 364.0 | 364.0 | 27.0 |
| LM2903DR | SOIC | D | 8 | 2500 | 340.5 | 338.1 | 20.6 |
| LM2903DRG3 | SOIC | D | 8 | 2500 | 364.0 | 364.0 | 27.0 |
| LM2903DRG4 | SOIC | D | 8 | 2500 | 340.5 | 336.1 | 25.0 |

| Device | Package Type | Package Drawing | Pins | SPQ | Length (mm) | Width (mm) | Height (mm) |
|---------------|--------------|-----------------|------|------|-------------|------------|-------------|
| LM2903DRG4 | SOIC | D | 8 | 2500 | 340.5 | 338.1 | 20.6 |
| LM2903PSR | SO | PS | 8 | 2000 | 356.0 | 356.0 | 35.0 |
| LM2903PWR | TSSOP | PW | 8 | 2000 | 356.0 | 356.0 | 35.0 |
| LM2903PWR | TSSOP | PW | 8 | 2000 | 364.0 | 364.0 | 27.0 |
| LM2903PWR | TSSOP | PW | 8 | 2000 | 356.0 | 356.0 | 35.0 |
| LM2903PWRG3 | TSSOP | PW | 8 | 2000 | 364.0 | 364.0 | 27.0 |
| LM2903PWRG4 | TSSOP | PW | 8 | 2000 | 356.0 | 356.0 | 35.0 |
| LM2903QDRG4 | SOIC | D | 8 | 2500 | 350.0 | 350.0 | 43.0 |
| LM2903VQDR | SOIC | D | 8 | 2500 | 340.5 | 338.1 | 20.6 |
| LM2903VQDR | SOIC | D | 8 | 2500 | 340.5 | 338.1 | 20.6 |
| LM2903VQDRG4 | SOIC | D | 8 | 2500 | 340.5 | 338.1 | 20.6 |
| LM2903VQPWR | TSSOP | PW | 8 | 2000 | 356.0 | 356.0 | 35.0 |
| LM2903VQPWR | TSSOP | PW | 8 | 2000 | 356.0 | 356.0 | 35.0 |
| LM2903VQPWRG4 | TSSOP | PW | 8 | 2000 | 356.0 | 356.0 | 35.0 |
| LM293ADGKR | VSSOP | DGK | 8 | 2500 | 358.0 | 335.0 | 35.0 |
| LM293ADGKR | VSSOP | DGK | 8 | 2500 | 366.0 | 364.0 | 50.0 |
| LM293ADGKR | VSSOP | DGK | 8 | 2500 | 370.0 | 355.0 | 55.0 |
| LM293ADGKR | VSSOP | DGK | 8 | 2500 | 364.0 | 364.0 | 27.0 |
| LM293ADR | SOIC | D | 8 | 2500 | 340.5 | 338.1 | 20.6 |
| LM293ADR | SOIC | D | 8 | 2500 | 364.0 | 364.0 | 27.0 |
| LM293ADR | SOIC | D | 8 | 2500 | 340.5 | 336.1 | 25.0 |
| LM293ADRG4 | SOIC | D | 8 | 2500 | 356.0 | 356.0 | 35.0 |
| LM293ADRG4 | SOIC | D | 8 | 2500 | 340.5 | 338.1 | 20.6 |
| LM293ADRG4 | SOIC | D | 8 | 2500 | 356.0 | 356.0 | 35.0 |
| LM293ADRG4 | SOIC | D | 8 | 2500 | 340.5 | 336.1 | 25.0 |
| LM293DGKR | VSSOP | DGK | 8 | 2500 | 364.0 | 364.0 | 27.0 |
| LM293DGKR | VSSOP | DGK | 8 | 2500 | 366.0 | 364.0 | 50.0 |
| LM293DR | SOIC | D | 8 | 2500 | 364.0 | 364.0 | 27.0 |
| LM293DR | SOIC | D | 8 | 2500 | 356.0 | 356.0 | 35.0 |
| LM293DR | SOIC | D | 8 | 2500 | 356.0 | 356.0 | 35.0 |
| LM293DRG3 | SOIC | D | 8 | 2500 | 364.0 | 364.0 | 27.0 |
| LM293DRG4 | SOIC | D | 8 | 2500 | 340.5 | 336.1 | 25.0 |
| LM293DRG4 | SOIC | D | 8 | 2500 | 340.5 | 338.1 | 20.6 |
| LM393ADGKR | VSSOP | DGK | 8 | 2500 | 358.0 | 335.0 | 35.0 |
| LM393ADGKR | VSSOP | DGK | 8 | 2500 | 364.0 | 364.0 | 27.0 |
| LM393ADGKR | VSSOP | DGK | 8 | 2500 | 346.0 | 346.0 | 35.0 |
| LM393ADR | SOIC | D | 8 | 2500 | 340.5 | 338.1 | 20.6 |
| LM393ADR | SOIC | D | 8 | 2500 | 364.0 | 364.0 | 27.0 |
| LM393ADR | SOIC | D | 8 | 2500 | 340.5 | 336.1 | 25.0 |
| LM393ADRG4 | SOIC | D | 8 | 2500 | 340.5 | 336.1 | 25.0 |
| LM393ADRG4 | SOIC | D | 8 | 2500 | 340.5 | 338.1 | 20.6 |
| LM393APSR | SO | PS | 8 | 2000 | 356.0 | 356.0 | 35.0 |
| LM393APWR | TSSOP | PW | 8 | 2000 | 364.0 | 364.0 | 27.0 |

| Device | Package Type | Package Drawing | Pins | SPQ | Length (mm) | Width (mm) | Height (mm) |
|-------------|--------------|-----------------|------|------|-------------|------------|-------------|
| LM393APWR | TSSOP | PW | 8 | 2000 | 356.0 | 356.0 | 35.0 |
| LM393APWR | TSSOP | PW | 8 | 2000 | 356.0 | 356.0 | 35.0 |
| LM393APWRG4 | TSSOP | PW | 8 | 2000 | 356.0 | 356.0 | 35.0 |
| LM393BIDDFR | SOT-23-THIN | DDF | 8 | 3000 | 210.0 | 185.0 | 35.0 |
| LM393BIDGKR | VSSOP | DGK | 8 | 2500 | 366.0 | 364.0 | 50.0 |
| LM393BIDR | SOIC | D | 8 | 2500 | 340.5 | 336.1 | 25.0 |
| LM393BIDSGR | WSON | DSG | 8 | 3000 | 210.0 | 185.0 | 35.0 |
| LM393BIPWR | TSSOP | PW | 8 | 2000 | 356.0 | 356.0 | 35.0 |
| LM393DGKR | VSSOP | DGK | 8 | 2500 | 366.0 | 364.0 | 50.0 |
| LM393DGKR | VSSOP | DGK | 8 | 2500 | 364.0 | 364.0 | 27.0 |
| LM393DR | SOIC | D | 8 | 2500 | 340.5 | 338.1 | 20.6 |
| LM393DR | SOIC | D | 8 | 2500 | 340.5 | 338.1 | 25.0 |
| LM393DRG3 | SOIC | D | 8 | 2500 | 333.2 | 345.9 | 28.6 |
| LM393DRG3 | SOIC | D | 8 | 2500 | 364.0 | 364.0 | 27.0 |
| LM393DRG4 | SOIC | D | 8 | 2500 | 340.5 | 338.1 | 20.6 |
| LM393DRG4 | SOIC | D | 8 | 2500 | 340.5 | 336.1 | 25.0 |
| LM393PSR | SO | PS | 8 | 2000 | 356.0 | 356.0 | 35.0 |
| LM393PWR | TSSOP | PW | 8 | 2000 | 364.0 | 364.0 | 27.0 |
| LM393PWR | TSSOP | PW | 8 | 2000 | 356.0 | 356.0 | 35.0 |
| LM393PWRG3 | TSSOP | PW | 8 | 2000 | 364.0 | 364.0 | 27.0 |
| LM393PWRG4 | TSSOP | PW | 8 | 2000 | 356.0 | 356.0 | 35.0 |

TUBE

*All dimensions are nominal

| Device | Package Name | Package Type | Pins | SPQ | L (mm) | W (mm) | T (µm) | B (mm) |
|------------|--------------|--------------|------|-----|--------|--------|--------|--------|
| LM2903D | D | SOIC | 8 | 75 | 506.6 | 8 | 3940 | 4.32 |
| LM2903D | D | SOIC | 8 | 75 | 507 | 8 | 3940 | 4.32 |
| LM2903DE4 | D | SOIC | 8 | 75 | 507 | 8 | 3940 | 4.32 |
| LM2903DE4 | D | SOIC | 8 | 75 | 506.6 | 8 | 3940 | 4.32 |
| LM2903DG4 | D | SOIC | 8 | 75 | 506.6 | 8 | 3940 | 4.32 |
| LM2903DG4 | D | SOIC | 8 | 75 | 507 | 8 | 3940 | 4.32 |
| LM2903P | P | PDIP | 8 | 50 | 506 | 13.97 | 11230 | 4.32 |
| LM2903QD | D | SOIC | 8 | 75 | 505.46 | 6.76 | 3810 | 4 |
| LM2903QDG4 | D | SOIC | 8 | 75 | 505.46 | 6.76 | 3810 | 4 |
| LM293AD | D | SOIC | 8 | 75 | 507 | 8 | 3940 | 4.32 |
| LM293AD | D | SOIC | 8 | 75 | 506.6 | 8 | 3940 | 4.32 |
| LM293ADE4 | D | SOIC | 8 | 75 | 506.6 | 8 | 3940 | 4.32 |
| LM293ADE4 | D | SOIC | 8 | 75 | 507 | 8 | 3940 | 4.32 |
| LM293D | D | SOIC | 8 | 75 | 507 | 8 | 3940 | 4.32 |
| LM293D | D | SOIC | 8 | 75 | 506.6 | 8 | 3940 | 4.32 |
| LM293P | P | PDIP | 8 | 50 | 506 | 13.97 | 11230 | 4.32 |
| LM293P | P | PDIP | 8 | 50 | 506.1 | 9 | 600 | 5.4 |
| LM293PE4 | P | PDIP | 8 | 50 | 506.1 | 9 | 600 | 5.4 |
| LM293PE4 | P | PDIP | 8 | 50 | 506 | 13.97 | 11230 | 4.32 |
| LM393AD | D | SOIC | 8 | 75 | 507 | 8 | 3940 | 4.32 |
| LM393AD | D | SOIC | 8 | 75 | 506.6 | 8 | 3940 | 4.32 |
| LM393ADE4 | D | SOIC | 8 | 75 | 506.6 | 8 | 3940 | 4.32 |
| LM393ADE4 | D | SOIC | 8 | 75 | 507 | 8 | 3940 | 4.32 |
| LM393ADG4 | D | SOIC | 8 | 75 | 507 | 8 | 3940 | 4.32 |
| LM393ADG4 | D | SOIC | 8 | 75 | 506.6 | 8 | 3940 | 4.32 |
| LM393AP | P | PDIP | 8 | 50 | 506 | 13.97 | 11230 | 4.32 |
| LM393AP | P | PDIP | 8 | 50 | 506.1 | 9 | 600 | 5.4 |
| LM393APE4 | P | PDIP | 8 | 50 | 506.1 | 9 | 600 | 5.4 |
| LM393APE4 | P | PDIP | 8 | 50 | 506 | 13.97 | 11230 | 4.32 |

| Device | Package Name | Package Type | Pins | SPQ | L (mm) | W (mm) | T (µm) | B (mm) |
|-----------|--------------|--------------|------|-----|--------|--------|--------|--------|
| LM393D | D | SOIC | 8 | 75 | 506.6 | 8 | 3940 | 4.32 |
| LM393D | D | SOIC | 8 | 75 | 507 | 8 | 3940 | 4.32 |
| LM393DE4 | D | SOIC | 8 | 75 | 506.6 | 8 | 3940 | 4.32 |
| LM393DE4 | D | SOIC | 8 | 75 | 507 | 8 | 3940 | 4.32 |
| LM393DG4 | D | SOIC | 8 | 75 | 507 | 8 | 3940 | 4.32 |
| LM393DG4 | D | SOIC | 8 | 75 | 506.6 | 8 | 3940 | 4.32 |
| LM393P | P | PDIP | 8 | 50 | 506 | 13.97 | 11230 | 4.32 |
| LM393P | P | PDIP | 8 | 50 | 506.1 | 9 | 600 | 5.4 |
| LM393PE3 | P | PDIP | 8 | 50 | 506.1 | 9 | 600 | 5.4 |
| LM393PE4 | P | PDIP | 8 | 50 | 506 | 13.97 | 11230 | 4.32 |
| LM393PW | PW | TSSOP | 8 | 150 | 530 | 10.2 | 3600 | 3.5 |
| LM393PWG4 | PW | TSSOP | 8 | 150 | 530 | 10.2 | 3600 | 3.5 |



D0008A

PACKAGE OUTLINE

SOIC - 1.75 mm max height

SMALL OUTLINE INTEGRATED CIRCUIT



4214825/C 02/2019

NOTES:

- Linear dimensions are in inches [millimeters]. Dimensions in parenthesis are for reference only. Controlling dimensions are in inches. Dimensioning and tolerancing per ASME Y14.5M.
- This drawing is subject to change without notice.
- This dimension does not include mold flash, protrusions, or gate burrs. Mold flash, protrusions, or gate burrs shall not exceed $.006$ [0.15] per side.
- This dimension does not include interlead flash.
- Reference JEDEC registration MS-012, variation AA.

EXAMPLE BOARD LAYOUT

D0008A

SOIC - 1.75 mm max height

SMALL OUTLINE INTEGRATED CIRCUIT



LAND PATTERN EXAMPLE
EXPOSED METAL SHOWN
SCALE:8X



SOLDER MASK DETAILS

4214825/C 02/2019

NOTES: (continued)

6. Publication IPC-7351 may have alternate designs.

7. Solder mask tolerances between and around signal pads can vary based on board fabrication site.

EXAMPLE STENCIL DESIGN

D0008A

SOIC - 1.75 mm max height

SMALL OUTLINE INTEGRATED CIRCUIT



SOLDER PASTE EXAMPLE
BASED ON .005 INCH [0.125 MM] THICK STENCIL
SCALE:8X

4214825/C 02/2019

NOTES: (continued)

8. Laser cutting apertures with trapezoidal walls and rounded corners may offer better paste release. IPC-7525 may have alternate design recommendations.
9. Board assembly site may have different recommendations for stencil design.

MECHANICAL DATA

PS (R-PDSO-G8)

PLASTIC SMALL-OUTLINE PACKAGE



- NOTES:
- A. All linear dimensions are in millimeters.
 - B. This drawing is subject to change without notice.
 - C. Body dimensions do not include mold flash or protrusion, not to exceed 0,15.

PS (R-PDSO-G8)

PLASTIC SMALL OUTLINE



- NOTES:
- A. All linear dimensions are in millimeters.
 - B. This drawing is subject to change without notice.
 - C. Publication IPC-7351 is recommended for alternate designs.
 - D. Laser cutting apertures with trapezoidal walls and also rounding corners will offer better paste release. Customers should contact their board assembly site for stencil design recommendations. Refer to IPC-7525 for other stencil recommendations.
 - E. Customers should contact their board fabrication site for solder mask tolerances between and around signal pads.

P (R-PDIP-T8)

PLASTIC DUAL-IN-LINE PACKAGE



- NOTES:
- A. All linear dimensions are in inches (millimeters).
 - B. This drawing is subject to change without notice.
 - C. Falls within JEDEC MS-001 variation BA.



- NOTES:
- A. All linear dimensions are in millimeters.
 - B. This drawing is subject to change without notice.
 - C. Publication IPC-7351 is recommended for alternate designs.
 - D. Laser cutting apertures with trapezoidal walls and also rounding corners will offer better paste release. Customers should contact their board assembly site for stencil design recommendations. Refer to IPC-7525 for other stencil recommendations.
 - E. Customers should contact their board fabrication site for solder mask tolerances between and around signal pads.

GENERIC PACKAGE VIEW

DSG 8

WSON - 0.8 mm max height

2 x 2, 0.5 mm pitch

PLASTIC SMALL OUTLINE - NO LEAD

This image is a representation of the package family, actual package may vary.
Refer to the product data sheet for package details.



4224783/A

DSG0008A



PACKAGE OUTLINE

WSON - 0.8 mm max height

PLASTIC SMALL OUTLINE - NO LEAD



ALTERNATIVE TERMINAL SHAPE TYPICAL



| SIDE WALL METAL THICKNESS DIM A | |
|---------------------------------|----------|
| OPTION 1 | OPTION 2 |
| 0.1 | 0.2 |

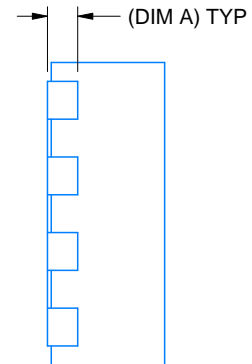

4218900/E 08/2022

NOTES:

1. All linear dimensions are in millimeters. Any dimensions in parenthesis are for reference only. Dimensioning and tolerancing per ASME Y14.5M.
2. This drawing is subject to change without notice.
3. The package thermal pad must be soldered to the printed circuit board for thermal and mechanical performance.

EXAMPLE BOARD LAYOUT

DSG0008A

WSON - 0.8 mm max height

PLASTIC SMALL OUTLINE - NO LEAD



LAND PATTERN EXAMPLE
SCALE:20X



SOLDER MASK DETAILS

4218900/E 08/2022

NOTES: (continued)

4. This package is designed to be soldered to a thermal pad on the board. For more information, see Texas Instruments literature number SLUA271 (www.ti.com/lit/slua271).
5. Vias are optional depending on application, refer to device data sheet. If any vias are implemented, refer to their locations shown on this view. It is recommended that vias under paste be filled, plugged or tented.

EXAMPLE STENCIL DESIGN

DSG0008A

WSON - 0.8 mm max height

PLASTIC SMALL OUTLINE - NO LEAD



SOLDER PASTE EXAMPLE
BASED ON 0.125 mm THICK STENCIL

EXPOSED PAD 9:
87% PRINTED SOLDER COVERAGE BY AREA UNDER PACKAGE
SCALE:25X

4218900/E 08/2022

NOTES: (continued)

6. Laser cutting apertures with trapezoidal walls and rounded corners may offer better paste release. IPC-7525 may have alternate design recommendations.

EXAMPLE BOARD LAYOUT

PW0008A

TSSOP - 1.2 mm max height

SMALL OUTLINE PACKAGE



LAND PATTERN EXAMPLE
SCALE:10X



SOLDER MASK DETAILS
NOT TO SCALE

4221848/A 02/2015

NOTES: (continued)

- 6. Publication IPC-7351 may have alternate designs.
- 7. Solder mask tolerances between and around signal pads can vary based on board fabrication site.

EXAMPLE STENCIL DESIGN

PW0008A

TSSOP - 1.2 mm max height

SMALL OUTLINE PACKAGE



SOLDER PASTE EXAMPLE
BASED ON 0.125 mm THICK STENCIL
SCALE:10X

4221848/A 02/2015

NOTES: (continued)

8. Laser cutting apertures with trapezoidal walls and rounded corners may offer better paste release. IPC-7525 may have alternate design recommendations.
9. Board assembly site may have different recommendations for stencil design.

DDF0008A



PACKAGE OUTLINE

SOT-23 - 1.1 mm max height

PLASTIC SMALL OUTLINE



NOTES:

1. All linear dimensions are in millimeters. Any dimensions in parenthesis are for reference only. Dimensioning and tolerancing per ASME Y14.5M.
2. This drawing is subject to change without notice.
3. This dimension does not include mold flash, protrusions, or gate burrs. Mold flash, protrusions, or gate burrs shall not exceed 0.15 mm per side.

EXAMPLE BOARD LAYOUT

DDF0008A

SOT-23 - 1.1 mm max height

PLASTIC SMALL OUTLINE



LAND PATTERN EXAMPLE
SCALE:15X



NON SOLDER MASK
DEFINED



SOLDER MASK
DEFINED

SOLDER MASK DETAILS

4222047/C 10/2022

NOTES: (continued)

4. Publication IPC-7351 may have alternate designs.
5. Solder mask tolerances between and around signal pads can vary based on board fabrication site.

EXAMPLE STENCIL DESIGN

DDF0008A

SOT-23 - 1.1 mm max height

PLASTIC SMALL OUTLINE



SOLDER PASTE EXAMPLE
BASED ON 0.125 mm THICK STENCIL
SCALE:15X

4222047/C 10/2022

NOTES: (continued)

6. Laser cutting apertures with trapezoidal walls and rounded corners may offer better paste release. IPC-7525 may have alternate design recommendations.
7. Board assembly site may have different recommendations for stencil design.

IMPORTANT NOTICE AND DISCLAIMER

TI PROVIDES TECHNICAL AND RELIABILITY DATA (INCLUDING DATA SHEETS), DESIGN RESOURCES (INCLUDING REFERENCE DESIGNS), APPLICATION OR OTHER DESIGN ADVICE, WEB TOOLS, SAFETY INFORMATION, AND OTHER RESOURCES "AS IS" AND WITH ALL FAULTS, AND DISCLAIMS ALL WARRANTIES, EXPRESS AND IMPLIED, INCLUDING WITHOUT LIMITATION ANY IMPLIED WARRANTIES OF MERCHANTABILITY, FITNESS FOR A PARTICULAR PURPOSE OR NON-INFRINGEMENT OF THIRD PARTY INTELLECTUAL PROPERTY RIGHTS.

These resources are intended for skilled developers designing with TI products. You are solely responsible for (1) selecting the appropriate TI products for your application, (2) designing, validating and testing your application, and (3) ensuring your application meets applicable standards, and any other safety, security, regulatory or other requirements.

These resources are subject to change without notice. TI grants you permission to use these resources only for development of an application that uses the TI products described in the resource. Other reproduction and display of these resources is prohibited. No license is granted to any other TI intellectual property right or to any third party intellectual property right. TI disclaims responsibility for, and you will fully indemnify TI and its representatives against, any claims, damages, costs, losses, and liabilities arising out of your use of these resources.

TI's products are provided subject to [TI's Terms of Sale](#) or other applicable terms available either on [ti.com](https://www.ti.com) or provided in conjunction with such TI products. TI's provision of these resources does not expand or otherwise alter TI's applicable warranties or warranty disclaimers for TI products.

TI objects to and rejects any additional or different terms you may have proposed.

Mailing Address: Texas Instruments, Post Office Box 655303, Dallas, Texas 75265
Copyright © 2023, Texas Instruments Incorporated